



Guidance Input and Output (GIO) Module

User Manual

Part Number 609622, Revision A



Brooks Automation

Information provided within this document is subject to change without notice, and although believed to be accurate, Brooks Automation assumes no responsibility for any errors, omissions, or inaccuracies.

AcuLigner™, Advan Tag™, AutoTeach™, ATR™, AXM™, BiSymmetrik™, CenterSmart™, Crate to Operate™, CrossingConnect™, DARTS™, Enerta™, e-RMA™, e-Spares™, e-Volution™, Falcon™, FIXLOAD™, FrogLeg™, GuardianPro™, Independent Twin Linear Exchange™, InCooler™, InLigner™, Isoport™, ITLX™, Jet™, Jet Engine™, LEAP™, LeapFrog™, LowProfile™, LPT™, M2 Nano™, Marathon 2, Marathon Express, PASIV™, Pathway™, PowerPak™, PowerTools™, PuroMaxx™, QuadraFly™, Radius™, Radient™, Radient Express™, Reliance™, Reliance ATR™, RetroEase™, SCARA™, SmartPM™, SMIF-INX™, SMIF-LPT™, SPOTLevel™, The New Pathway to Productivity™, Time Optimized Trajectory™, Time Optimal Trajectory™, Time Optimized Path™, TopCooler™, TopLigner™, VacuTran™, VersaPort™, WaferEngine™, LEAP™, Pathway™, GIO, GSB, Guidance 6600, Guidance 6430, Guidance 6420, Guidance 6410, Guidance 6000, Guidance 3400, Guidance 3300, Guidance 3200, Guidance 2600, Guidance 2400, Guidance 2300, Guidance 2200, Guidance 1400, Guidance 1300, Guidance 1200, Guidance 0200 Slave Amplifier, Guidance 0006, Guidance 0004, Guidance Controller, Guidance Development Environment, GDE, Guidance Development Suite, GDS, Guidance Dispense, Guidance Input and Output Module, Guidance Programming Language, GPL, Guidance Slave Board, Guidance System, Guidance System D4/D6, PreciseFlex™ 300, PreciseFlex™ 400, PreciseFlex™ 3400, PreciseFlex™ 1300, PreciseFlex™ 1400, PreciseFlex™ DD4, PreciseFlex™ DD6, PreciseFlex™ DDR, PreciseFlex™ G5400, PreciseFlex™ G5600, PreciseFlex™ G6400, PreciseFlex™ G6410, PreciseFlex™ G6420, PreciseFlex™ G6430, PreciseFlex™ G6600, PreciseFlex™ GSBP Slave Amp, PreciseFlex™ PFD0, PrecisePlace 100, PrecisePlace 0120, PrecisePlace 0130, PrecisePlace 0140, PrecisePlace 1300, PrecisePlace 1400, PrecisePlace 2300, PrecisePlace 2400, PrecisePower 300, PrecisePower 500, PrecisePower 1000, PrecisePower 2000, PreciseVision, and RIO logos are trademarks of Brooks Automation.

Fusion®, Guardian®, MagnaTran®, Marathon®, Razor®, Spartan®, Vision®, Zaris®, and the Brooks and design logo are registered U.S. trademarks of Brooks Automation.

All other trademarks are properties of their respective owners.

© 2024 Brooks Automation. All rights reserved. The information included in this manual is proprietary information of Brooks Automation, and is provided for the use of Brooks customers only and cannot be used for distribution, reproduction, or sale without the express written permission of Brooks Automation.

This technology is subject to United States export Administration Regulations and authorized to the destination only; diversion contrary to U.S. law is prohibited.

<p>Brooks Automation 15 Elizabeth Drive Chelmsford, MA 01824-2400 Tel: +1 978-262-2400 Fax: +1 978-262-2500</p>	<p>Brooks Automation, PreciseFlex Collaborative Robots 201 Lindbergh Avenue Livermore, CA 94551 Tel: +1-408-224-2838</p>
---	---



Worldwide Headquarters

15 Elizabeth Drive
Chelmsford, MA 01824 U.S.A.

Brooks Automation, PreciseFlex Collaborative Robots

201 Lindbergh Avenue
Livermore, CA 94551 U.S.A

Technical Support

Location	Contact	Website
North America	+1-800-447-5007 (Toll-Free) +1-978-262-2900 (Local) +1-408-224-2838 (PreciseFlex™)	http://www.brooks.com/
Europe	support_preciseflex@brooksautomation.com	
Japan	+81 120-255-390 (Toll Free) +81 45-330-9005 (Local)	
China	+86 21-5131-7066	
Taiwan	+886 080-003-5556 (Toll Free) +886 3-5525258 (Local)	
Korea	1800-5116 (Toll Free)	
Singapore	+65 1-800-4-276657 (Toll Free) +65 6309 0701 (Local)	

General Emails

Division	Email Address
Sales	sales_preciseflex@brooksautomation.com
Technical Support	support_preciseflex@brooksautomation.com
Technical Publications	Technical.Publications@brooksautomation.com

Revision History

Revision	ECO	Date	Action	Author
A	EC147326	08/03/2023	Releasing manual at Rev. A to follow standard Brooks technical publication styles.	M. Ashenfelder



Table of Contents

1. Safety	1
Safety Setup	1
Authorized Personnel Only	1
Explanation of Hazards and Alerts	2
Safety Text	2
Safety Icons	2
Signal Words and Color	2
Alert Example	3
General Safety Considerations	4
Mechanical Hazards	6
Electrical Hazards	7
Ergonomic Hazards	8
Emergency Stop Circuit (E-Stop)	10
Recycling and Hazardous Materials	10
2. Introduction to the Hardware	11
Guidance Input and Output (GIO) Module Overview	11
3. Installation, Configuration, and Software	13
Mounting and Installation	13
GIO Hardware and Software Configuration	14
GIO Board Unit Number	14
RS-485 Signal Termination	15
Controller Software Configuration	15
24VDC Logic Power Considerations	16
Communication Timing Considerations	16
Accessing GIO Remote DIO	17
4. Hardware Reference	18
Guidance Input and Output (GIO) Hardware Overview	18
Digital Input and Output Signals	19
RS-485 Signal / 24VDC Power Connector	24
RS-485 Termination Jumper	26
Status Red/Green LED	26
Unit Number Jumpers	27
GIO Board Jumpers	28
Appendix A: Product Specifications	31

1. Safety

Safety Setup

Brooks uses caution, warning, and danger labels to convey critical information required for the safe and proper operation of the hardware and software. Read and comply with all labels to prevent personal injury and damage to the equipment.

 DANGER Read the Safety Chapter	
<p>Failure to review the <i>Safety</i> chapter and follow the safety warnings can result in serious injury or death.</p> <ul style="list-style-type: none">• All personnel involved with the operation or maintenance of this product must read and understand the information in this safety chapter.• Follow all applicable safety codes of the facility as well as national and international safety codes.• Know the facility safety procedures, safety equipment, and contact information.• Read and understand each procedure before performing it.	

Authorized Personnel Only

This product is intended for use by trained and experienced personnel. Operators must comply with applicable organizational operating procedures, industry standards, and all local, regional, national, and international laws and regulations.

Explanation of Hazards and Alerts

This manual and this product use industry standard hazard alerts to notify the user of personal or equipment safety hazards. Hazard alerts contain safety text, icons, signal words, and colors.

Safety Text

Hazard alert text follows a standard, fixed-order, three-part format.





- Identify the hazard
- State the consequences if the hazard is not avoided
- State how to avoid the hazard.

Safety Icons

- Hazard alerts contain safety icons that graphically identify the hazard.
- The safety icons in this manual conform to ISO 3864 and ANSI Z535 standards.

Signal Words and Color

Signal words inform of the level of hazard.

	<p>Danger indicates a hazardous situation which, if not avoided, will result in serious injury or death.</p> <p>The Danger signal word is white on a red background with an exclamation point inside a yellow triangle with black border.</p>
	<p>Warning indicates a hazardous situation which, if not avoided, could result in serious injury or death.</p> <p>The Warning signal word is black on an orange background with an exclamation point inside a yellow triangle with black border.</p>
	<p>Caution indicates a hazardous situation or unsafe practice which, if not avoided, may result in minor or moderate personal injury.</p> <p>The Caution signal word is black on a yellow background with an exclamation point inside a yellow triangle with black border.</p>
	<p>Notice indicates a situation or unsafe practice which, if not avoided, may result in equipment damage.</p> <p>The Notice signal word is white on blue background with no icon.</p>



Alert Example

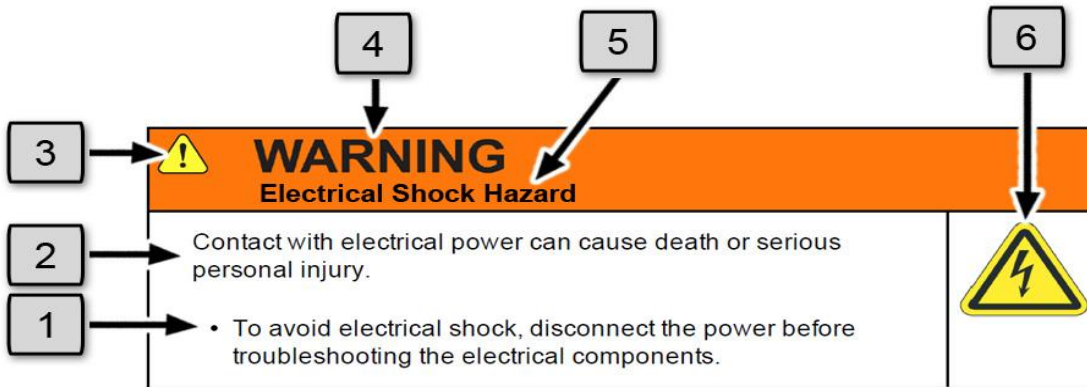

The following is an example of a Warning hazard alert.







Number	Description
1.	How to Avoid the Hazard
2.	Source of Hazard and Severity
3.	General Alert Icon
4.	Signal Word
5.	Type of Hazard
6.	Hazard Symbol(s)



General Safety Considerations



 WARNING Software	
<p>Software is not safety rated. Unplanned motion can occur as long as power is supplied to the motors. Maximum torque could be momentarily applied that may cause equipment damage or personal injury.</p> <ul style="list-style-type: none">• Only operate the robot with its covers installed.• Guarantee that safety controller features are in place (for example, an emergency stop button and protective stop).• Regularly test safety components to prove that they function correctly.	 



 WARNING Robot Mounting	
<p>Before applying power, the robot must be mounted on a rigid test stand, secure surface, or system application. Improperly mounted robots can cause excessive vibration and uncontrolled movement that may cause equipment damage or personal injury.</p> <ul style="list-style-type: none">• Always mount the robot on a secure test stand, surface, or system before applying power.	



 WARNING Do Not Use Unauthorized Parts	
<p>Using parts with different inertial properties with the same robot application can cause the robot's performance to decrease and potentially cause unplanned robot motion that could result in serious personal injury.</p> <ul style="list-style-type: none">• Do not use unauthorized parts.• Confirm that the correct robot application is being used.	

 WARNING Magnetic Field Hazard	
<p>This product contains magnetic motors that can be hazardous to implanted medical devices, such as pacemakers, and cause personal harm, severe injury, or death.</p> <ul style="list-style-type: none"> • Maintain a safe working distance of 30 cm from the motor when with an energized robot if you use a cardiac rhythm management device. 	



 CAUTION Unauthorized Service	
<p>Personal injury or damage to equipment may result if this product is operated or serviced by untrained or unauthorized personnel.</p> <ul style="list-style-type: none"> • Only qualified personnel who have received certified training and have the proper job qualifications are allowed to transport, assemble, operate, or maintain the product. 	



 CAUTION Damaged Components	
<p>The use of this product when components or cables appear to be damaged may cause equipment malfunction or personal injury.</p> <ul style="list-style-type: none"> • Do not use this product if components or cables appear to be damaged. • Place the product in a location where it will not get damaged. • Route cables and tubing so that they do not become damaged and do not present a personal safety hazard. 	



 CAUTION Inappropriate Use	
<p>Use of this product in a manner or for purposes other than for what it is intended may cause equipment damage or personal injury.</p> <ul style="list-style-type: none"> • Only use the product for its intended application. • Do not modify this product beyond its original design. • Always operate this product with the covers in place. 	

 CAUTION Seismic Restraint	
<p>The use of this product in an earthquake-prone environment may cause equipment damage or personal injury.</p> <ul style="list-style-type: none">• The user is responsible for determining whether the product is used in an earthquake prone environment and installing the appropriate seismic restraints in accordance with local regulations.	

Mechanical Hazards



 CAUTION Pinch Point	
<p>Moving parts of the product may cause squeezing or compression of fingers or hands resulting in personal injury.</p> <ul style="list-style-type: none">• Do not operate the product without the protective covers in place.	



 WARNING Automatic Movement	
<p>Whenever power is applied to the product, there is the potential for automatic or unplanned movement of the product or its components, which could result in personal injury.</p> <ul style="list-style-type: none">• Follow safe practices for working with energized products per the facility requirements.• Do not rely on the system software or process technology to prevent unexpected product motion.• Do not operate the product without its protective covers in place.• While the collaborative robotics system is designed to be safe around personnel, gravity and other factors may present hazards and should be considered.	



 CAUTION Vibration Hazard	
<p>As with any servo-based device, the robot can enter a vibratory state resulting in mechanical and audible hazards. Vibration indicates a serious problem. Immediately remove power.</p> <ul style="list-style-type: none"> • Before energizing, ensure the robot is bolted to a rigid metal chamber or stand. 	

Electrical Hazards

Refer to the specifications of the *Guidance Controller Quick Start Guide* for the electrical power.



 DANGER Electrical Shock Hazard	
<p>Contact with electrical power can cause personal harm and serious injury.</p> <ul style="list-style-type: none"> • To avoid electrical shock, disconnect the power before troubleshooting the electrical components. • Check the unit's specifications for the actual system power requirements and use appropriate precautions. • Never operate this product without its protection covers on. 	



 WARNING Electrical Burn	
<p>Improper electrical connection or connection to an improper electrical supply can result in electrical burns resulting in equipment damage, serious injury, or death.</p> <ul style="list-style-type: none"> • Always provide the robot with the proper power supply connectors and ground that are compliant with appropriate electrical codes. 	



 WARNING Electrical Fire Hazard	
<p>All energized electrical equipment poses the risk of fire, which may result in severe injury or death. Fires in wiring, fuse boxes, energized electrical equipment, computers, and other electrical sources require a Class C extinguisher.</p> <ul style="list-style-type: none">• Use a fire extinguisher designed for electrical fires (Class C in the US and Class E in Asia).• It is the facility's responsibility to determine if any other fire extinguishers are needed for the system that the robot is in.	

NOTICE	
<p>Improper handling of the power source or connecting devices may cause component damage or equipment fire.</p> <ul style="list-style-type: none">• Connect the system to an appropriate electrical supply.• Turn off the power before servicing the unit.• Turn off the power before disconnecting the cables.	

Ergonomic Hazards



 CAUTION Heavy Lift Hazard	
<p>Failure to take the proper precautions before moving the robot could result in back injury and muscle strain.</p> <ul style="list-style-type: none">• Use a lifting device and cart rated for the weight of the drive or arm.• Only persons certified in operating the lifting device should be moving the product.	

 CAUTION Tipover Hazard	
<p>This product has a high center of gravity which may cause the product to tip over and cause serious injury.</p> <ul style="list-style-type: none">• Always properly restrain the product when moving it.• Never operate the robot unless it is rigidly mounted.	

 CAUTION Trip Hazard	
<p>Cables for power and communication and facilities create trip hazards which may cause serious injury.</p> <ul style="list-style-type: none">• Always route the cables where they are not in the way of traffic.	

Emergency Stop Circuit (E-Stop)

The integrator of the robot must provide an emergency stop switch.

 WARNING Emergency Stop Circuit	
<p>Using this product without an emergency stop circuit may cause personal injury.</p> <ul style="list-style-type: none">• Customer is responsible for integrating an emergency stop circuit into their system.• Do not override or bypass the emergency stop circuit.	

Recycling and Hazardous Materials

Brooks Automation complies with the EU Directive 2002/96/EU Waste Electrical and Electronic Equipment (WEEE).

The end user must responsibly dispose of the product and its components when disposal is required. The initial cost of the equipment does not include cost for disposal. For further information and assistance in disposal, please email Brooks Automation Technical Support at support@preciseflex@brooksautomation.com.

2. Introduction to the Hardware



Guidance Input and Output (GIO) Module Overview

The Guidance Input and Output (GIO) module is a very compact device that connects to any Guidance Controller and adds an additional twelve (12) optically isolated remote digital input channels and eight (8) optically isolated remote digital output channels.

GIO modules interface to a controller via a two-wire, bi-directional, daisy chained RS-485 line, and can be located up to approximately six (6) meters from the controller. Depending upon the timing requirements of the application and the available 24VDC power, a mix of as many as eight (8) GIO's or Guidance Slave Boards (GSBs) may be connected to a RS-485 cable. (For PreciseFlex™ 400 Sample Handlers with Linear Rails that include two internal GSBs, only two additional GIOs or GSBs can be connected due to 24VDC power limitations.)



Figure 2-1: Guidance Input and Output (GIO) Module

 WARNING	
<p>The GIO contains unshielded 24VDC signals and pins. This product is intended to be mounted in a cabinet or machine chassis that is not accessible when power is turned on.</p>	

Once the GIO and the Guidance Controller are interfaced, the on/off states of the GIO digital inputs and outputs are automatically transferred to the controller via the PreciseFlex Servo Network protocol. Application programs running on the controller can access the GIO input and output values as though they were local to the controller. The only consideration is that GIO values are delayed somewhat because they are periodically transferred via the network protocol.

For systems that require an even greater number of remote digital inputs and/or outputs or other types of IO interfaces, or those that require that the I/O be located a greater distance from a Guidance Controller, Brooks sells an Ethernet-based Remote Input and Output Module (RIO). For detailed information on the Guidance Controller or the RIO, refer to the *Brooks PreciseFlex Library*.

3. Installation, Configuration, and Software

Mounting and Installation

The Guidance Input and Output (GIO) module is an open frame device with exposed 24VDC and must be mounted inside of a cabinet or other enclosure. The mounting holes are shown in **Blue** in [Figure 3-1](#) with dimensions in millimeters. There should be sufficient airflow across this board to ensure that the components do not become excessively hot.

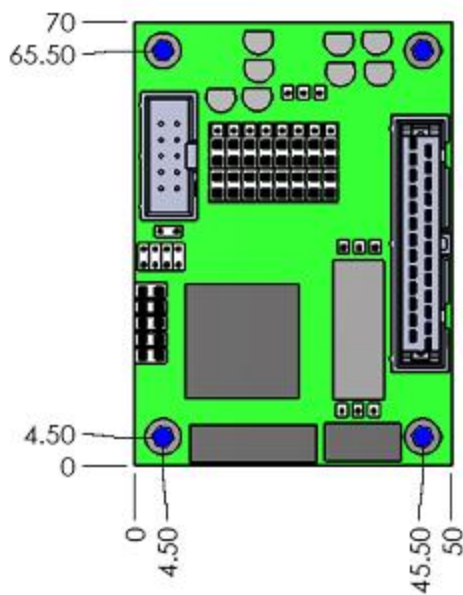



Figure 3-1: GIO Mounting Holes

 **WARNING**

The GIO contains unshielded 24VDC signals and pins. This product is intended to be mounted in a cabinet or machine chassis that is not accessible when power is turned on.



GIO Hardware and Software Configuration

GIO Board Unit Number

Up to a maximum of eight (8) GIOs or Guidance Slave Boards (GSBs) can be theoretically interfaced to a Guidance Controller. Therefore, this section describes how to configure and address up to 8 GIO or GSB boards. However, due to communication timing and 24VDC power considerations, which are described below, a maximum combination of four (4) GIOs or GSBs is a more practical limit except for special system configurations.

GIOs and GSBs can be connected to the RS-485 daisy chain in any order without altering their operation or identification. A GIO or GSB is not identified by a unit number that is embedded in its low-level communication messages. This unit number is specified by jumpers on the GIO. A GIO's unit number is automatically combined with "GIO_" to generate a keyword that is used to configure the communication protocol between the GIO and its master controller. The unit number can be arbitrary selected and does not need to be sequentially assigned, but each GIO or GSB must have a unique unit number within a given RS-485 system.

The setting of the GIO's [Unit Number Jumpers](#) is presented in [Table 3-1](#) along with the corresponding unit number and keyword identifier.

NOTE: The Unit Number Jumpers for the GIO are J7/J8/J9, whereas the GSB utilizes J8/J9/J10.

Table 3-1: The Setting of the GIO's Unit Number Jumpers

J7	J8	J9	GIO Unit	GIO Keyword
In	In	In	1	GIO_1
Out	In	In	2	GIO_2
In	Out	In	3	GIO_3

J7	J8	J9	GIO Unit	GIO Keyword
Out	Out	In	4	GIO_4
In	In	Out	5	GIO_5
Out	In	Out	6	GIO_6
In	Out	Out	7	GIO_7
Out	Out	Out	8	GIO_8

RS-485 Signal Termination

There is one hardware configuration option that is dependent upon the ordering of modules in the RS-485 daisy chain. For noise immunity, termination jumpers must be installed on the GIOs, GSBs, or controller on the extreme ends of the RS-485 daisy chain. The termination jumpers must be removed for all controllers or boards in between. On the GIO board, the [Termination Jumper](#) is labeled J6. Consult the hardware description for a specific master controller to determine its RS-485 termination jumper location.

Controller Software Configuration

For the controller to communicate with an IO module, the GIO's GIO_Keyword must be entered into the "Servo network node identifier" (DataID 151) parameter database array in the master controller. This provides the controller with the information required to communicate with the GIO board. The position of the GIO_Keyword in the DataID 151 array assigns the board a "network node number." Within the controller's software environment, the network node number (and not the GIO's unit number) is used to reference DIO on the GIO board. By convention, the first network node is always the master controller and the first element of the DataID 151 is always the controller's serial number.

For example, if the GIO Unit Number Jumpers are set to select unit #4 (Keyword GIO_4), to define the GIO as the second network node, DataID 151 should be defined as follows:

```
DataID 151: "<master>," "GIO_4", "", "", "", "", ...
```

Normally, only elements at the end of the DataID 151 array can be blank and a blank entry cannot precede any non-blank servo node entry. As a special case, blank entries may occur before a GIO keyword. So the user could enter DataID 151 as follows:

```
DataID 151: "<master>," "", "", "", "", "GIO_4"
```

This allows GIO boards to be assigned to fixed node numbers regardless of how many other slave boards might be in the system. Having a fixed node number means the I/O signal numbers are also fixed.

24VDC Logic Power Considerations

The GIO must be provided with 24VDC to power both the board's logic and to drive the input and output signals. The amount of 24VDC power available for GIO boards may limit the number of boards that can be wired in a system.

As a wiring convenience, GIOs and GSBs typically draw the 24VDC power from the same 10-pin daisy chained ribbon cable that provides the RS-485 signals. In this configuration, the Guidance Controller and its associated 24VDC power supply provide the logic and signal power to the GIOs and GSBs.

As of 2013, all Guidance Controllers can output a maximum of 2A at 24VDC on the 10-pin RS-485 connector assuming that the controller's 24VDC power supply has sufficient power. Prior to 2013, this was limited to only 1.35A.

The minimum power requirement for the GIO's logic is 0.05A. In the worst case, where a board's digital outputs are all configured as sourcing and are driving 100mA and the digital inputs are configured as sourcing as well, a single GIO could draw 1.05A or more. Even with 2A available from the controller, at most, two (2) GIOs could be supported by the power available from a controller.

Fortunately, in a typical system, even if the GIO's digital outputs are configured as sourcing, 20mA to 50mA of drive per channel is more common. The user can expect a typical GIO configured with sourcing outputs to draw 0.5A, which permits up to four (4) GIOs to be interfaced to a single controller.

If GSBs are interfaced as well, their power consumption must be taken into account as well as any motor power that is drawn from the controller's 24VDC via the RS-485 cable.

If the controller's available power on the RS-485 cable is not sufficient for an application, an external 24VDC power source can be wired to the GIO and GSB boards (although this is not as convenient) or the digital signals could be configured as sinking if practical.

Communication Timing Considerations

Each GSB exchanges messages with the master controller every motion control trajectory cycle. The trajectory period is determined by the parameter "Trajectory Generator update period in sec" (DataID 600) on the master controller. This parameter typically ranges from 1-4 msec and determines the delay in reading or writing input and output values on the GIO.

As the number of GIO and/or GSB boards increases, the trajectory period must also be increased in order to accommodate the increased transmission times. [Table 3-2](#) shows the maximum number of GSB or GIO nodes possible for different trajectory periods.

Table 3-2: Trajectory Periods, Maximum Number of GSB or GIO Nodes

Trajectory period (msec)	Maximum number of GIO or GSB nodes
1	1
2	4
4	8

Accessing GIO Remote DIO

Once the GIO and the Guidance controller are configured, the general-purpose digital input and output signals on the GIO can be easily accessed from the controller as remote I/O signals. The update period for these signal values is the same as the trajectory period set by "Trajectory Generator update period in sec" (DataID 600) on the master controller.

To specify a GIO's general-purpose digital I/O signal from the master controller, multiply the GIO's network node number (not the GIO's unit number) by 100000 and add the I/O signal's number. For example, to access a GIO board configured as the 2nd or nth network node, add 200000 or 100000*n to the signal number.

Table 3-3: Network Node, Signal Offset, and GIO Module

Node	Signal Offset	GIO Module	
		Outputs (8)	Inputs (12)
2	200000	200013-200020	210001-210012
n	100000*n	n00013-n00020	n10001-n10012

4. Hardware Reference

Guidance Input and Output (GIO) Hardware Overview

The Guidance Input and Output (GIO) module provides additional digital input and output signal interfaces that further enhance a Guidance Controller's ability to connect to external equipment. The interfaces and configuration hardware for this module include the following:

- [Digital Inputs / Outputs Connector](#)
- [RS-485 Signal / 24VDC Power Connector](#)
- [RS-485 Termination Jumper](#)
- [Status Red/Green LED](#)
- [Unit Number Jumpers](#)

Figure 4-1 illustrates the top surface of the GIO and identifies each of the user connectors and the major configuration components. To jump to the detailed information for a specific connector, click on the connector interface name or the connector.

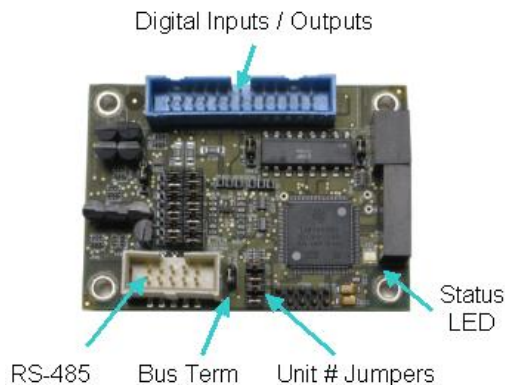



Figure 4-1: The Top Surface of the GIO

 WARNING	
The GIO contains unshielded 24VDC signals and pins. This product is intended to be mounted in a cabinet or machine chassis that is not accessible when power is turned on.	

The pin outs for each of the connectors and the settings for the jumpers are described in the following sections.

Digital Input and Output Signals

The GIO board provides twelve (12) general purpose optically-isolated digital input signals and eight (8) general purpose optically isolated digital output signals. These signals are presented in a single 26-pin IDC compatible connector with retaining latches. This type of connector permits these signals to be easily interfaced to other devices.

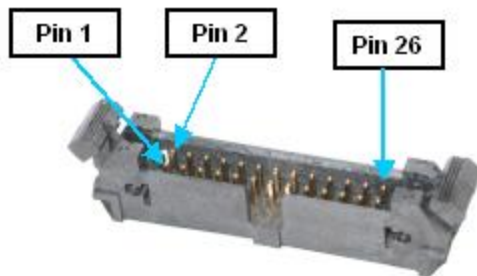

Figure 4-2: 26-pin IDC Compatible Connector with Retaining Latches

Depending upon the setting of the [Sinking Versus Sourcing Inputs Jumpers \(J3, J4, J5\)](#), the inputs are configured as "sinking" or "sourcing" in groups of 4 signals. J3 configures inputs 1-4, J4 configures inputs 5-8, and J5 configures inputs 9-12.

If an input signal is configured as "sinking," the external equipment must provide a 5VDC to 24VDC voltage to indicate a logical high value or no voltage for a logical low. This configuration is compatible with "sourcing" (PNP) sensors.

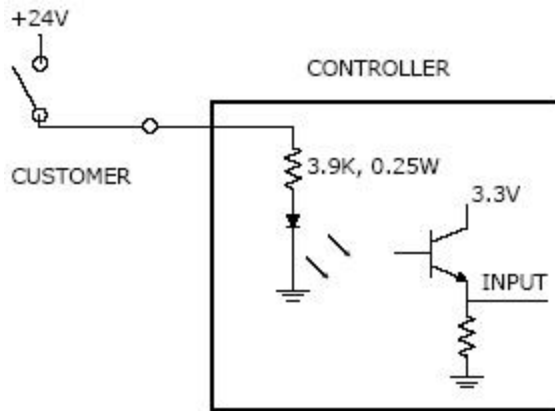

Figure 4-3: Sinking Digital Input

If an input signal is configured as "sourcing," the external equipment must pull the signal input pin to ground to indicate a logical high and must let the line float high to 24VDC to signal a logical low value. This configuration is compatible with "sinking" (NPN) sensors.

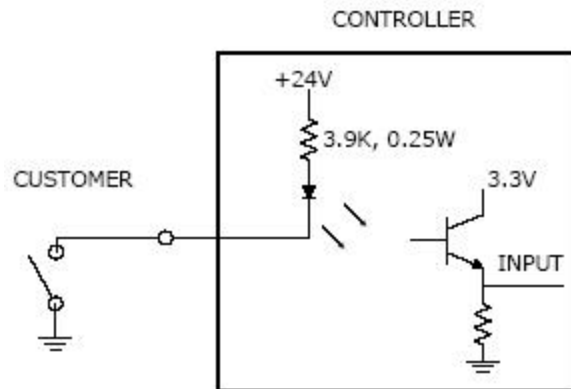

Figure 4-4: Sourcing Digital Input

As shipped from the factory, all digital inputs are normally configured as "sourcing."

By setting eight (8) sets of [Sinking Versus Sourcing Output Jumpers \(J11\)](#), each output can be individually configured as either "sinking" or "sourcing."

If an output signal is "sinking," the external equipment must provide a 5VDC to 24VDC pull-up voltage on the output pin and the GIO pulls this pin to ground when the signal is asserted as true. This configuration is compatible with "sourcing" (PNP) devices.

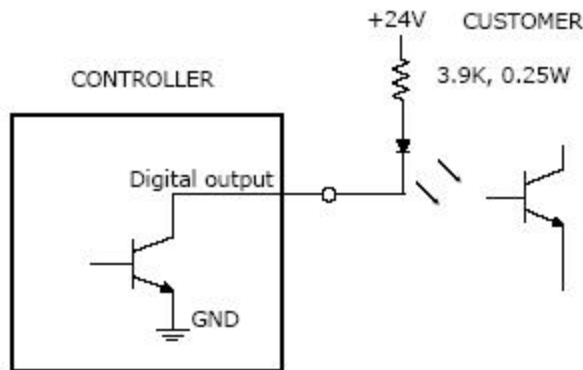

Figure 4-5: Sinking Digital Output

If an output signal is "sourcing," the external equipment must pull-down the output pin to ground and the GIO pulls this pin to 24VDC when the signal is asserted as true. This configuration is compatible with "sinking" (NPN) devices.

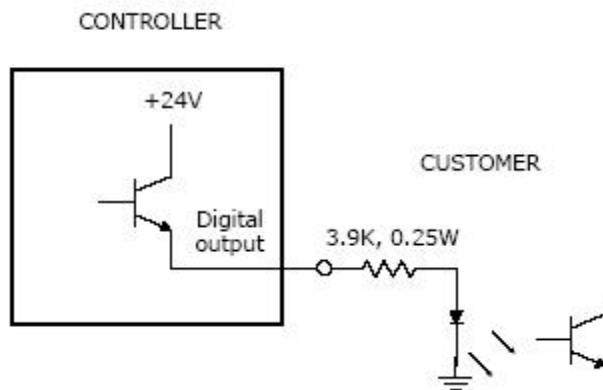

Figure 4-6: Sourcing Digital Output

As shipped from the factory, all digital outputs are normally configured as "sinking."

The pin out for the Digital Input and Output Connector and the corresponding GPL signal numbers are described in the following table. For the GPL signal numbers "n" is the GIO's Network Node number that is defined when configuring the controller, not the GIO's unit number.

Table 4-1: Digital Input and Output Connector Pin Out & Corresponding GPL Signal Numbers

Signal	GPL Signal Number	Pin	Pin	GPL Signal Number Figure 4-7: Sourcing Digital Input	Signal
GND		1	2		GND
Input 1	n10001	3	4	n10002	Input 2
Input 3	n10003	5	6	n10004	Input 4
Input 5	n10005	7	8	n10006	Input 6
Input 7	n10007	9	10	n10008	Input 8
Input 9	n10009	11	12	n10010	Input 10
Input 11	n10011	13	14	n10012	Input 12
24VDC		15	16		24VDC
Output 1	n00013	17	18	n00014	Output 2
Output 3	n00015	19	20	n00016	Output 4
Output 5	n00017	21	22	n00018	Output 6
Output 7	n00019	23	24	n00020	Output 8
24VDC		25	26		GND
User Plug Parts	Molex 90142-0026. The sockets for this plug are 90110-2110 and the Molex crimp tool is a 63811-1000. Alternately, an IDC plug can be used, Samtec part # HCSD-13-01-N				

If the GIO board is installed within an enclosure, it is often convenient to use a ribbon cable whose ends are terminated with an IDC plug and a female DB25 connector to present the digital input and output signals on the enclosure's facilities panel. For example, if a GIO is installed inside a PreciseFlex™ 400 Sample Handler, this type of cable is used to connect the GIO to a DB25 plug that can be accessed from the outside at the base of the robot.

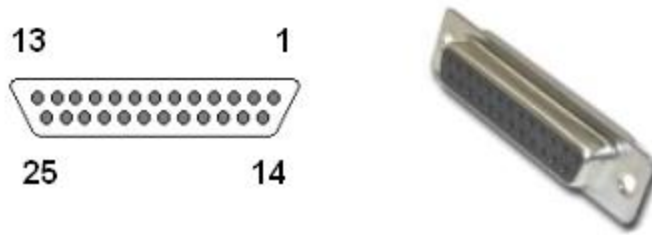

Figure 4-8: DB25 Female

In this case, the 26th pin of the GIO's Digital Input and Output Signals Connector is not utilized. The pin numbers for the signals are changed due to the DB25 pin numbering scheme. The revised pin numbers and the corresponding GPL signal numbers are described in [Table 4-2](#). For the GPL signal numbers "n" is the GIO's Network Node number that is defined when configuring the controller, not the GIO's unit number.

Table 4-2: Revised Pin Numbers & Corresponding GPL Signal Numbers

Signal	GPL Signal Number	Pin	Pin	GPL Signal Number	Signal
GND		1	14		GND
Input 1	n10001	2	15	n10002	Input 2
Input 3	n10003	3	16	n10004	Input 4
Input 5	n10005	4	17	n10006	Input 6
Input 7	n10007	5	18	n10008	Input 8
Input 9	n10009	6	19	n10010	Input 10
Input 11	n10011	7	20	n10012	Input 12
24VDC		8	21		24VDC
Output 1	n00013	9	22	n00014	Output 2
Output 3	n00015	10	23	n00016	Output 4
Output 5	n00017	11	24	n00018	Output 6
Output 7	n00019	12	25	n00020	Output 8
24VDC		13			
User Plug Parts	DB25 Male Plug				

RS-485 Signal / 24VDC Power Connector

The GIO communicates with a Guidance Controller using a RS-485 interface. RS-485 is a two-wire, bi-directional, multi-drop, daisy chained, high-speed serial interface. Once the GIO and controller are connected and configured, the controller's operating system automatically manages reading and writing the digital input and output signals on the GIO at a regular interval without requiring special programming.

The RS-485 signals are provided in an IDC connector. To simplify wiring, this connector also provides the 24VDC and ground lines that are necessary to operate the GIO. If a single GIO module is interfaced to a Guidance Controller, a simple ribbon cable with an IDC connector on each end can connect the GIO to the controller and provide both communication signals and power to the GIO.

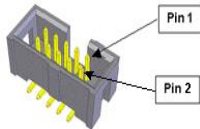

Figure 4-9: IDC Connector

For reliable communications, [termination jumpers](#) must be installed on the GIOs, GSBs, or controllers on the extreme ends of the RS-485 daisy chain. The termination jumpers must be removed for all controllers or boards in between.

The pin out for the RS-485/Power Connector is described in [Table 4-3](#).

Table 4-3: Pin Out for the RS-485/Power Connector

Pin	Description
1	24VDC. A minimum of 0.05 Amps is required for the GIO's logic power. A maximum of 1 Amp additional is required when all eight (8) digital outputs are configured as sourcing and are driving 100mA each and all of the digital inputs are configured as sourcing as well. If the digital outputs are driving less than 100ma each, the additional 1 Amp will be reduced accordingly. In a typical system, sourcing outputs normally drive 20mA to 50mA.
2	
3	GND
4	GND
5	GND
6	GND
7	GND

Pin	Description
8	RS485+
9	RS485-
10	GND
User Plug Part No	AMP 746285-1 or Molex 22-55-2101 or 90142-0010. For the Molex plug, use Molex pins 16-02-0103 and Molex crimp tool 63811-1000.

RS-485 Termination Jumper

For the RS-485 daisy chained serial bus to operate properly, the ends of the bus must be electrically terminated. This electrical termination prevents transmitted signals from being reflected back into the cable and corrupting valid data. However, interior boards in the daisy chain must not have any electrical termination.

To allow a GIO to be placed anywhere in a RS-485 daisy chain, this board includes configurable bus termination that is controlled by [two jumper posts at position J6](#) on the top surface of the board.



Figure 4-10: Jumper Posts

When a GIO is placed at either end of a RS-485 daisy chain, the two (2) posts must be jumpered together to terminate the bus. When a GIO is placed at an interior node of a chain, the jumper must be removed. As shipped from the factory, the jumper is installed and the GIO is ready to be connected at either end of a chain.

Status Red/Green LED

The GIO module includes a Status LED mounted on its top surface. This indicates the power and execution state of the board. The interpretation of the red and green LED is described in [Table 4-4](#).

Table 4-4: Interpretation of Red and Green LED

LED State	System Status	Description
Continuously off or on	(1) Logic power off or (2) CPU crashed	Normally indicates that 24VDC logic power is off. In rare instances, indicates that the GIO CPU has crashed due to a system hardware or software error.
Alternating red and green	Board booting	The 24VDC logic power has been turned on and the GIO board is being initialized. NOTE: <i>If this state continues for more than a minute or two, it usually indicates a hardware failure.</i>

LED State	System Status	Description
Blinking red single	Board operating, waiting for communications.	The GIO CPU has completed its start-up process and is operational. The GIO is waiting for RS-485 communication with the master Guidance Controller to be established.
Blinking red double	Board idle, not communicating	The GIO did not connect to the master controller within 1 minute of boot and is no longer listening to the RS-485. It will not connect until it has been rebooted.
Blinking green	Normal operation, IO active	The GIO is operational and is actively communicating with the master Guidance Controller. The input and output signals on the board are active.

Unit Number Jumpers

In the low-level RS-485 communications, the "unit number" determines which GIO is the originator or recipient of each message, not the position of the GIO board in the RS-485 daisy chain. This unit number is configurable using a group of three (3) jumper posts on the top of the GIO board. The unit numbers can be arbitrarily assigned and do not have to be sequential, but they do have to be unique within a controller system.



Figure 4-11: Unit Number Jumper

The unit number also determines a keyword ("GIO_<unit_number>") that is specified to configure a GIO board as a node in a controller's Servo Network.

NOTE: At the software application level, the network node number and not the GIO board unit number determines [how the GIO's digital input and output lines are addressed](#).

For more information on node numbers and configuring the controller, see the [Hardware and Software Configuration](#) section of this manual.

In [Table 4-5](#), the interpretation of the [Unit Number Jumpers \(J7, J8, J9\)](#) is provided. As shipped from the factory, all of the jumpers are installed, which indicates GIO unit #1.

NOTE: The Unit Number Jumpers for the GIO are J7/J8/J9 whereas the GSB utilizes J8/J9/J10.

Table 4-5: Interpretation of Unit Number Jumpers (J7, J8, J9)

J7	J8	J9	GIO Unit	GIO Keyword
In	In	In	1	GIO_1
Out	In	In	2	GIO_2
In	Out	In	3	GIO_3
Out	Out	In	4	GIO_4
In	In	Out	5	GIO_5
Out	In	Out	6	GIO_6
In	Out	Out	7	GIO_7
Out	Out	Out	8	GIO_8

GIO Board Jumpers

The GIO board has a number of hardware jumpers that determine the configuration of various hardware functions. Depending upon the type of jumper, there may be two, three or five jumper posts. Posts are tied (shorted) together using black jumper plugs. The five (5) wide jumper posts for configuring the digital output signals are shown in [Figure 4-12](#).



Figure 4-12: GIO Board Jumpers

The locations of each of the key sets of jumpers are illustrated in [Figure 4-13](#) and are identified by stenciled labels on the surface of the GIO board.

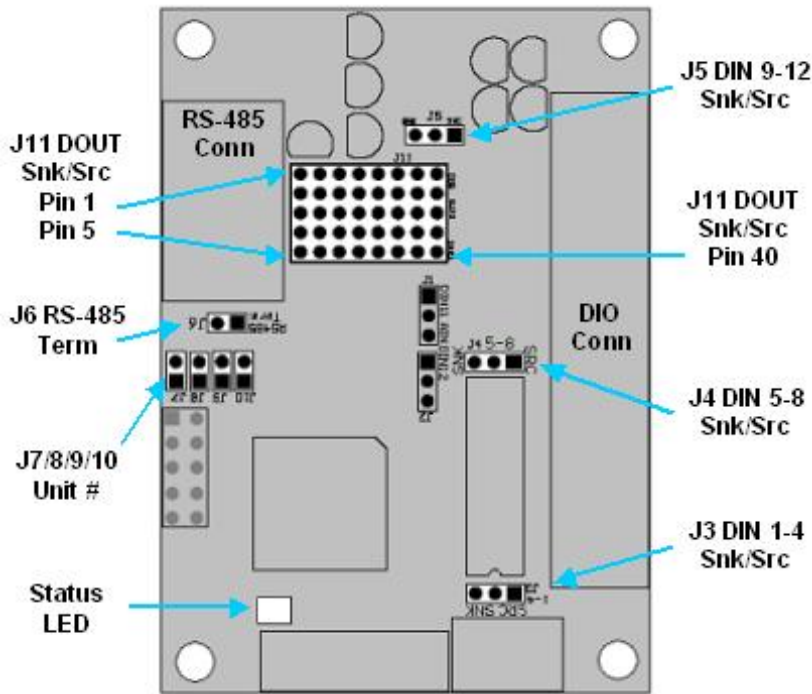

Figure 4-13: Locations of Key Sets of Jumpers

Table 4-6 describes each of the sets of jumpers and how the pins must be shorted ("jumped") in order to set a specific configuration. When a direction (e.g. left versus right) is described, it is with respect to the GIO board oriented as shown in Figure 4-13.

Table 4-6: Sets of Jumpers & How Pins Must Be Shorted

Jumpers	Description	Setting
J11 Digital Outputs Sink/Source	<p>These jumpers determine if each of the Digital Output Signals is "sinking" or "sourcing." This array of jumpers consists of eight (8) columns of five (5) posts. Each column determines the setting for a single digital output. The left column (pins 1-5) control to the first digital output signal. To set an output to sourcing, two(2) jumpers must be installed on the top four (4) posts. To set an output to sinking, two (2) jumpers must be installed on the bottom four (4) posts. For example, to set the first output to sinking, a jumper should short pins 2 and 3 and a second jumper should short pins 4 and 5.</p> <p>NOTE: <i>As shipped from the factory, all outputs are set to sinking.</i></p>	<p>For sinking, short bottom four posts using two jumpers</p> <p>For Sourcing, short top four posts using two jumpers</p>
J10 Spare Jumper	<p>This is the right most jumper in the J7/J8/J9/J10 group and is currently unused.</p> <p>NOTE: <i>As shipped from the factory, this jumper always is installed.</i></p>	Always installed

Jumpers	Description	Setting
J7/J8/J9 Unit Number	<p>In the low-level RS-485 communication protocol, the Unit Number determines which GIO is the originator or recipient of each message, not the position of the GIO board in the RS-485 daisy chain. See the Unit Number Jumper section for a description of these jumpers. The left most jumper is J7.</p> <p>NOTE: <i>As shipped from the factory, all three (3) of these jumpers are installed and the board is set to unit #1.</i></p>	Install or remove to define GIO Unit Number.
J6 RS-485 Bus Termination	<p>This jumper controls if RS-485 Bus Termination is enabled on this board. For reliable communications, if a GIO is at the end of a RS-485 daisy chain, this jumper must be installed to terminate the communication line. If a GIO is in the middle of a RS-485 daisy chain, this jumper must be uninstalled to disable the termination.</p> <p>NOTE: <i>As shipped from the factory, this jumper is installed and the GIO should be installed at the end of the RS-485 daisy chain.</i></p>	Install jumper J6 to terminate the RS-485 communication lines.
J3/J4/J5 Digital Inputs Sink/Source	<p>These jumpers configure the "sinking" or "sourcing" mode of operation for the Digital Input Signals in groups of four (4). J3 configures inputs 1-4, J4 configures inputs 5-8, and J5 configures inputs 9-12. Each jumper consists of three (3) posts. If the left posts are jumpered, the group of input signals is configured as sinking. If the right posts are jumpered, the group of inputs is configured as sourcing.</p> <p>NOTE: <i>As shipped from the factory, all inputs are set to sourcing.</i></p>	<p>For Sinking, jumper left two posts.</p> <p>For Sourcing, jumper right two posts.</p>
Status LED	This is a green and red LED that blinks to indicate the operational status of the controller.	

Appendix A: Product Specifications

Table 5-1: Guidance Input & Output (GIO) Module Specifications

General Specification	Range & Features
Interface to Guidance Controller	
Communications Interface	Interfaces via a two-wire, bi-directional, daisy chained RS-485 line and can be located up to approximately six (6) meters away from the controller.
Communications Protocol	Operates as part of the PreciseFlex Servo Network.
Scanning Rate	Input and output states are updated at the rate set by the "Trajectory Generator update period in sec" (DataID 600) of the master controller. This update rate is typically 1-4 msec.
Number of units	A combination of up to eight (8) GIOs and GSBs can theoretically be simultaneously interfaced to a Guidance Controller. The actual maximum is a function of the "Trajectory Generator update period in sec" (DataID 600) of the master controller and the available 24VDC power. In typical systems, a maximum of four (4) GIO or GSB boards can be simultaneously operated.
Input and Output Interfaces	
Digital Input Channels	12 optically isolated digital inputs Configurable in banks of 4 as sinking or sourcing 5VDC to 24VDC for logic high if sinking 24VDC supplied for logic high if sourcing
Digital Output Channels	8 optically isolated digital outputs Individually configured as sinking or sourcing 24VDC maximum pull up
General	
Size and Weight	50mm (W) x 70mm (L) x 15.5mm (H), 0.040 kg

General Specification	Range & Features
Low Voltage Logic Power	<p>24VDC required for logic and input/output functions</p> <p>A minimum of 0.05 Amps is required for logic power. A maximum of 1 Amp additional is required when all eight (8) digital outputs are configured as sourcing and are driving 100mA each and all of the digital inputs are configured as sourcing. If the digital outputs are driving less than 100ma each, the additional 1 Amp will be reduced accordingly. In a typical system, sourcing outputs normally drive 20mA to 50mA.</p>