



Guidance 6000 Controllers

User Manual

Part Number 613245, Revision A



Brooks Automation

Information provided within this document is subject to change without notice, and although believed to be accurate, Brooks Automation assumes no responsibility for any errors, omissions, or inaccuracies.

AcuLigner™, Advan Tag™, AutoTeach™, ATR™, AXM™, BiSymmetrik™, CenterSmart™, Crate to Operate™, CrossingConnect™, DARTS™, Enerta™, e-RMA™, e-Spares™, e-Volution™, Falcon™, FIXLOAD™, FrogLeg™, GuardianPro™, Independent Twin Linear Exchange™, InCooler™, InLigner™, Isoport™, ITLX™, Jet™, Jet Engine™, LEAP™, LeapFrog™, LowProfile™, LPT™, M2 Nano™, Marathon 2, Marathon Express, PASIV™, Pathway™, PowerPak™, PowerTools™, PuroMaxx™, QuadraFly™, Radius™, Radiant™, Radiant Express™, Reliance™, Reliance ATR™, RetroEase™, SCARA™, SmartPM™, SMIF-INX™, SMIF-LPT™, SPOTLevel™, The New Pathway to Productivity™, Time Optimized Trajectory™, Time Optimal Trajectory™, Time Optimized Path™, TopCooler™, TopLigner™, VacuTran™, VersaPort™, WaferEngine™, LEAP™, Pathway™, GIO, GSB, Guidance 6600, Guidance 6430, Guidance 6420, Guidance 6410, Guidance 6000, Guidance 3400, Guidance 3300, Guidance 3200, Guidance 2600, Guidance 2400, Guidance 2300, Guidance 2200, Guidance 1400, Guidance 1300, Guidance 1200, Guidance 0200 Slave Amplifier, Guidance 0006, Guidance 0004, Guidance Controller, Guidance Development Environment, GDE, Guidance Development Suite, GDS, Guidance Dispense, Guidance Input and Output Module, Guidance Programming Language, GPL, Guidance Slave Board, Guidance System, Guidance System D4/D6, PreciseFlex™ 300, PreciseFlex™ 400, PreciseFlex™ 3400, PreciseFlex™ 1300, PreciseFlex™ 1400, PreciseFlex™ DD4, PreciseFlex™ DD6, PreciseFlex™ DDR, PreciseFlex™ G5400, PreciseFlex™ G5600, PreciseFlex™ G6400, PreciseFlex™ G6410, PreciseFlex™ G6420, PreciseFlex™ G6430, PreciseFlex™ G6600, PreciseFlex™ GSBP Slave Amp, PreciseFlex™ PFD0, PrecisePlace 100, PrecisePlace 0120, PrecisePlace 0130, PrecisePlace 0140, PrecisePlace 1300, PrecisePlace 1400, PrecisePlace 2300, PrecisePlace 2400, PrecisePower 300, PrecisePower 500, PrecisePower 1000, PrecisePower 2000, PreciseVision, and RIO logos are trademarks of Brooks Automation.

Fusion®, Guardian®, MagnaTran®, Marathon®, Razor®, Spartan®, Vision®, Zaris®, and the Brooks and design logo are registered U.S. trademarks of Brooks Automation.

All other trademarks are properties of their respective owners.

© 2024 Brooks Automation. All rights reserved. The information included in this manual is proprietary information of Brooks Automation, and is provided for the use of Brooks customers only and cannot be used for distribution, reproduction, or sale without the express written permission of Brooks Automation.

This technology is subject to United States export Administration Regulations and authorized to the destination only; diversion contrary to U.S. law is prohibited.

<p>Brooks Automation 15 Elizabeth Drive Chelmsford, MA 01824-2400 Tel: +1 978-262-2400 Fax: +1 978-262-2500</p>	<p>Brooks Automation, PreciseFlex Collaborative Robots 201 Lindbergh Avenue Livermore, CA 94551 Tel: +1-408-224-2838</p>
--------------------------------------------------------------------------------------------------------------------------------------------	-------------------------------------------------------------------------------------------------------------------------------------------------



Worldwide Headquarters

15 Elizabeth Drive
Chelmsford, MA 01824 U.S.A.

Brooks Automation, PreciseFlex Collaborative Robots

201 Lindbergh Avenue
Livermore, CA 94551 U.S.A

Technical Support

Location	Contact	Website
North America	+1-800-447-5007 (Toll-Free) +1-978-262-2900 (Local) +1-408-224-2838 (PreciseFlex™)	
Europe	support_preciseflex@brooksautomation.com	
Japan	+81 120-255-390 (Toll Free) +81 45-330-9005 (Local)	
China	+86 21-5131-7066	http://www.brooks.com/
Taiwan	+886 080-003-5556 (Toll Free) +886 3-5525258 (Local)	
Korea	1800-5116 (Toll Free)	
Singapore	+65 1-800-4-276657 (Toll Free) +65 6309 0701 (Local)	

General Emails

Division	Email Address
Sales	sales_preciseflex@brooksautomation.com
Technical Support	support_preciseflex@brooksautomation.com
Technical Publications	Technical.Publications@brooksautomation.com

Revision History

Revision	ECO	Date	Action	Author
A	EC148615	3/7/2023	Released manual at Rev. A to follow standard Brooks technical publication styles.	M. Ashenfelder

Table of Contents



1. Safety	1
Safety Setup	1
Authorized Personnel Only	1
Explanation of Hazards and Alerts	2
Safety Text	2
Safety Icons	2
Signal Words and Color	2
Alert Example	3
General Safety Considerations	4
Mechanical Hazards	6
Electrical Hazards	7
Ergonomic Hazards	8
Emergency Stop Circuit (E-Stop)	10
Recycling and Hazardous Materials	10
2. Introduction to the Hardware	11
System Overview	11
System Description	11
System Diagram	13
System Components	14
PreciseFlex G6000 Controllers	14
Low-Voltage Power Supply	16
Intelligent Motor Power Supplies	16
Remote Front Panel, E-Stop Box, and Manual Control Pendant	19
Remote IO Module	20
Machine Vision Software and Cameras	21
Status LED and Status Output Signal	21
Machine Safety	23
Voltage and Power Considerations	23
Enclosure Interlocks	23
E-Stop Stopping Time and Distance	25
Safety Zones	26
Safety Standards Reference Material	31
Standards Compliance and Agency Certifications	31
Moving Machine Safety	32
3. Installation Information	33
Heat Sinking and Mounting	33
Recommended Motor and Encoder Wiring	35
Wiring Overview	35
Motor Cables	35
Motor Wiring Path	36
Motor Ferrite Beads	38
Brake Wiring	38
Ferrite Bead Installation Illustration	38

Encoder Considerations	41
Encoder Cables	41
Encoder Wiring and Pin Assignments	42
4. Hardware Reference	44
PreciseFlex™ Controller Assemblies and Interfaces	44
PreciseFlex Controller Major Assemblies	44
Power Connectors and Grounding	45
Communication Interfaces	47
HVCPU Board Encoder Interfaces	67
HVAMP Motor/Brake Interfaces	72
Low-Voltage Power Supply	77
Motor Voltage Power Supplies	78
PrecisePower 300 Intelligent Motor Power Supply	78
PrecisePower 1000 Intelligent Motor Power Supply	80
PrecisePower 2000 Intelligent Motor Power Supply	81
Safety Circuits For Remote Front Panel	84
5. Third-Party Equipment	87
Third Party Equipment Overview	87
Panasonic A4/A5/A6 Serial Incremental/Absolute Encoders	87
Tamagawa Serial Incremental/Absolute Encoder	89
Yaskawa Sigma II/III Serial Absolute Encoder	91
Nikon A/Sanyo Denki Serial Absolute Encoders	92
EnDat / SII / BiSS Serial Absolute Encoders	94
Appendix A. Product Specifications	95
PreciseFlex G6000 Controller Specifications	95
PreciseFlex G6000 Controller Environmental Specifications	98
PrecisePower 300 Intelligent Motor Power Supply Specifications	99
PrecisePower 1000 Intelligent Motor Power Supply Specifications	99
PrecisePower 2000 Intelligent Motor Power Supply Specifications	100
Appendix B. Frequently Asked Questions (FAQs)	102
Frequently Asked Questions	102
Is there an alternative to purchasing crimping tools for connectors?	102
How do you connect a robot power enable button?	103
How does the user release the motor brakes in a 1 or 2-axis system?	103
Why should grippers be wired to release when digital signals are ON?	104
What are the restrictions on assigning encoder and amplifier channels?	104

1. Safety

Safety Setup

Brooks uses caution, warning, and danger labels to convey critical information required for the safe and proper operation of the hardware and software. Read and comply with all labels to prevent personal injury and damage to the equipment.

 DANGER Read the Safety Chapter	
<p>Failure to review the <i>Safety</i> chapter and follow the safety warnings can result in serious injury or death.</p> <ul style="list-style-type: none">• All personnel involved with the operation or maintenance of this product must read and understand the information in this safety chapter.• Follow all applicable safety codes of the facility as well as national and international safety codes.• Know the facility safety procedures, safety equipment, and contact information.• Read and understand each procedure before performing it.	

Authorized Personnel Only

This product is intended for use by trained and experienced personnel. Operators must comply with applicable organizational operating procedures, industry standards, and all local, regional, national, and international laws and regulations.

Explanation of Hazards and Alerts

This manual and this product use industry standard hazard alerts to notify the user of personal or equipment safety hazards. Hazard alerts contain safety text, icons, signal words, and colors.

Safety Text

Hazard alert text follows a standard, fixed-order, three-part format.





- Identify the hazard
- State the consequences if the hazard is not avoided
- State how to avoid the hazard.

Safety Icons

- Hazard alerts contain safety icons that graphically identify the hazard.
- The safety icons in this manual conform to ISO 3864 and ANSI Z535 standards.

Signal Words and Color

Signal words inform of the level of hazard.

	<p>Danger indicates a hazardous situation which, if not avoided, will result in serious injury or death.</p> <p>The Danger signal word is white on a red background with an exclamation point inside a yellow triangle with black border.</p>
	<p>Warning indicates a hazardous situation which, if not avoided, could result in serious injury or death.</p> <p>The Warning signal word is black on an orange background with an exclamation point inside a yellow triangle with black border.</p>
	<p>Caution indicates a hazardous situation or unsafe practice which, if not avoided, may result in minor or moderate personal injury.</p> <p>The Caution signal word is black on a yellow background with an exclamation point inside a yellow triangle with black border.</p>
	<p>Notice indicates a situation or unsafe practice which, if not avoided, may result in equipment damage.</p> <p>The Notice signal word is white on blue background with no icon.</p>



Alert Example

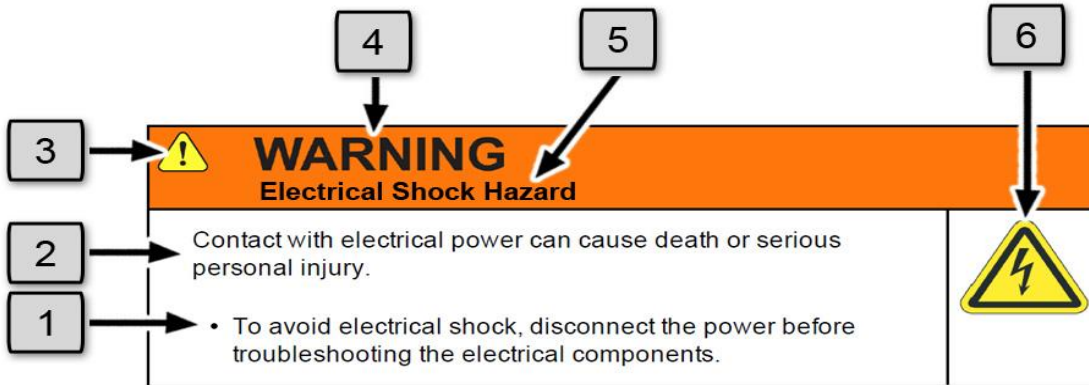

The following is an example of a Warning hazard alert.







Number	Description
1.	How to Avoid the Hazard
2.	Source of Hazard and Severity
3.	General Alert Icon
4.	Signal Word
5.	Type of Hazard
6.	Hazard Symbol(s)



General Safety Considerations



 WARNING Software	
<p>Software is not safety rated. Unplanned motion can occur as long as power is supplied to the motors. Maximum torque could be momentarily applied that may cause equipment damage or personal injury.</p> <ul style="list-style-type: none">• Only operate the robot with its covers installed.• Guarantee that safety controller features are in place (for example, an emergency stop button and protective stop).• Regularly test safety components to prove that they function correctly.	 



 WARNING Robot Mounting	
<p>Before applying power, the robot must be mounted on a rigid test stand, secure surface, or system application. Improperly mounted robots can cause excessive vibration and uncontrolled movement that may cause equipment damage or personal injury.</p> <ul style="list-style-type: none">• Always mount the robot on a secure test stand, surface, or system before applying power.	



 WARNING Do Not Use Unauthorized Parts	
<p>Using parts with different inertial properties with the same robot application can cause the robot's performance to decrease and potentially cause unplanned robot motion that could result in serious personal injury.</p> <ul style="list-style-type: none">• Do not use unauthorized parts.• Confirm that the correct robot application is being used.	

 WARNING Magnetic Field Hazard	
<p>This product contains magnetic motors that can be hazardous to implanted medical devices, such as pacemakers, and cause personal harm, severe injury, or death.</p> <ul style="list-style-type: none">• Maintain a safe working distance of 30 cm from the motor when with an energized robot if you use a cardiac rhythm management device.	



 CAUTION Unauthorized Service	
<p>Personal injury or damage to equipment may result if this product is operated or serviced by untrained or unauthorized personnel.</p> <ul style="list-style-type: none">• Only qualified personnel who have received certified training and have the proper job qualifications are allowed to transport, assemble, operate, or maintain the product.	

 CAUTION Damaged Components	
<p>The use of this product when components or cables appear to be damaged may cause equipment malfunction or personal injury.</p> <ul style="list-style-type: none">• Do not use this product if components or cables appear to be damaged.• Place the product in a location where it will not get damaged.• Route cables and tubing so that they do not become damaged and do not present a personal safety hazard.	



 CAUTION Inappropriate Use	
<p>Use of this product in a manner or for purposes other than for what it is intended may cause equipment damage or personal injury.</p> <ul style="list-style-type: none">• Only use the product for its intended application.• Do not modify this product beyond its original design.• Always operate this product with the covers in place.	

 CAUTION Seismic Restraint	
<p>The use of this product in an earthquake-prone environment may cause equipment damage or personal injury.</p> <ul style="list-style-type: none"> The user is responsible for determining whether the product is used in an earthquake prone environment and installing the appropriate seismic restraints in accordance with local regulations. 	

Mechanical Hazards

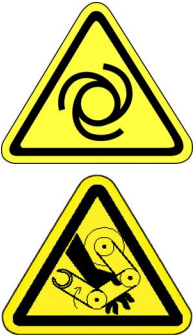

 CAUTION Pinch Point	
<p>Moving parts of the product may cause squeezing or compression of fingers or hands resulting in personal injury.</p> <ul style="list-style-type: none"> Do not operate the product without the protective covers in place. 	



 WARNING Automatic Movement	
<p>Whenever power is applied to the product, there is the potential for automatic or unplanned movement of the product or its components, which could result in personal injury.</p> <ul style="list-style-type: none"> Follow safe practices for working with energized products per the facility requirements. Do not rely on the system software or process technology to prevent unexpected product motion. Do not operate the product without its protective covers in place. While the collaborative robotics system is designed to be safe around personnel, gravity and other factors may present hazards and should be considered. 	



 CAUTION Vibration Hazard	
<p>As with any servo-based device, the robot can enter a vibratory state resulting in mechanical and audible hazards. Vibration indicates a serious problem. Immediately remove power.</p> <ul style="list-style-type: none">• Before energizing, ensure the robot is bolted to a rigid metal chamber or stand.	

Electrical Hazards

Refer to the specifications of the *Guidance Controller Quick Start Guide* for the electrical power.



 DANGER Electrical Shock Hazard	
<p>Contact with electrical power can cause personal harm and serious injury.</p> <ul style="list-style-type: none">• To avoid electrical shock, disconnect the power before troubleshooting the electrical components.• Check the unit's specifications for the actual system power requirements and use appropriate precautions.• Never operate this product without its protection covers on.	



 WARNING Electrical Burn	
<p>Improper electrical connection or connection to an improper electrical supply can result in electrical burns resulting in equipment damage, serious injury, or death.</p> <ul style="list-style-type: none">• Always provide the robot with the proper power supply connectors and ground that are compliant with appropriate electrical codes.	



 WARNING Electrical Fire Hazard	
<p>All energized electrical equipment poses the risk of fire, which may result in severe injury or death. Fires in wiring, fuse boxes, energized electrical equipment, computers, and other electrical sources require a Class C extinguisher.</p> <ul style="list-style-type: none">• Use a fire extinguisher designed for electrical fires (Class C in the US and Class E in Asia).• It is the facility's responsibility to determine if any other fire extinguishers are needed for the system that the robot is in.	

NOTICE	
<p>Improper handling of the power source or connecting devices may cause component damage or equipment fire.</p> <ul style="list-style-type: none">• Connect the system to an appropriate electrical supply.• Turn off the power before servicing the unit.• Turn off the power before disconnecting the cables.	

Ergonomic Hazards



 CAUTION Heavy Lift Hazard	
<p>Failure to take the proper precautions before moving the robot could result in back injury and muscle strain.</p> <ul style="list-style-type: none">• Use a lifting device and cart rated for the weight of the drive or arm.• Only persons certified in operating the lifting device should be moving the product.	

 CAUTION Tipover Hazard	
<p>This product has a high center of gravity which may cause the product to tip over and cause serious injury.</p> <ul style="list-style-type: none">• Always properly restrain the product when moving it.• Never operate the robot unless it is rigidly mounted.	

 CAUTION Trip Hazard	
<p>Cables for power and communication and facilities create trip hazards which may cause serious injury.</p> <ul style="list-style-type: none">• Always route the cables where they are not in the way of traffic.	

Emergency Stop Circuit (E-Stop)

The integrator of the robot must provide an emergency stop switch.

 WARNING Emergency Stop Circuit	
<p>Using this product without an emergency stop circuit may cause personal injury.</p> <ul style="list-style-type: none">• Customer is responsible for integrating an emergency stop circuit into their system.• Do not override or bypass the emergency stop circuit.	

Recycling and Hazardous Materials

Brooks Automation complies with the EU Directive 2002/96/EU Waste Electrical and Electronic Equipment (WEEE).

The end user must responsibly dispose of the product and its components when disposal is required. The initial cost of the equipment does not include cost for disposal. For further information and assistance in disposal, please email Brooks Automation Technical Support at support@preciseflex@brooksautomation.com.

2. Introduction to the Hardware

System Overview

System Description

The PreciseFlex™ G6000s are PreciseFlex's next generation of intelligent multi-axis robotic motion controllers. These devices integrate motion control, kinematics, motor drives, I/O signals, networking communications, and machine vision in an extremely compact and cost-effective design. A single controller can drive from one to six motors and includes features to control robotic mechanisms such as a general purpose 6-axis articulated robot, wafer handlers for the semiconductor industry, plate handlers for the Life Sciences, Delta robots for packaging, and Cartesian mechanisms for dispensing. When needed, multiple controllers can be integrated in a distributed network to operate more complex robots or simultaneously coordinate multiple robots. The high-level of control provided by the G6000s permits robots to be easily taught and programmed in Cartesian coordinates. In simpler applications, these controllers are appropriate for operating single or multiple axes of uncoordinated motion control. This new family replaces the PreciseFlex Guidance 3000 and 2000 controllers, and offers additional features and performance for similar prices.

The PreciseFlex G6000 Controllers require an external 24VDC power supply for their logic and IO and an external motor supply to power their integrated motor drives. The motor power supply voltage can range from 24VDC to 340VDC, allowing a wide variety of motor sizes to be controlled. These controllers are very compact and are intended to be mounted near the point of use, which in many cases means they will be embedded in the mechanism to be controlled rather than in an external cabinet. This can significantly reduce the cost of cables, connectors and sheet metal and reduce the footprint of the system. The G6000 Series includes a 4-axis (PreciseFlex G6400) and a 6-axis (PreciseFlex G6600) model, both with integrated motor drives. The 4-axis version can be configured to provide a range of peak motor currents to match the power requirements of various motors. The 6-axis version provides a mix of peak motor currents drives to operate both large primary motors and smaller end of tool motors.

Motion axes can be grouped into “robots,” which are defined by a geometric (“kinematic”) model. This geometric model permits the robot to be taught and moved in Cartesian coordinates, which is more intuitive than working with individual axes. Many kinematic modules also include a dynamic model of the robot that can significantly improve the tracking and servo performance of the system. A “robot” has a master controller that executes the kinematic model and transmits axis position

commands to both integrated drives and those contained on networked controllers. The logical grouping of axes into robots is independent of the physical configuration of the motion controllers. For example, a networked 4-axis G6400 and a lower powered 4-axis G5400 controller can be logically grouped into one 6-axis robot and two 1-axis robots. From a programming point of view, all of these axes operate as though the motor drives were contained in the master controller.

Each PreciseFlex Controller can have several types of peripherals attached to it. These include cameras, remote I/O, a hardware manual control pendant, and a remote front panel.

These controllers include a web-based operator interface that is viewed via a standard browser. This interface is used for configuring the system, and starting, stopping and monitoring execution. The web interface can be accessed over a local network or remotely via the Internet. This remote interface is of great benefit in system maintenance and debugging. First time users, read the *Setup and Operation Quick Start Guide* (PN 0000-DI-00010) for instructions on interfacing a PC to a controller via the web interface and for general operating instructions.

The PreciseFlex G6000s are programmed using a PC connected via Ethernet. There are three programming modes: a simple Digital IO mode, an Embedded Language mode, and a PC Control mode. When programmed in the DIO or Embedded Language mode, the PC can be removed after programming is completed and the controller will operate standalone. A PC is required for operation in the PC Control mode. For a description of the embedded language and its development environment, see the *Guidance Programming Language, Introduction to GPL* (PN GPL0-DI-S0010) and the *Guidance Development Environment, Introduction and Reference Manual* (PN GDE0-DI-S0010). For information on an open source PC control package, see the documentation for the *TCP Command Server*.

These controllers are designed to operate with an optional, easy-to-use machine vision software package, "PreciseVision." This vision system can be executed in a PC connected through Ethernet or, shortly, in a networked processor. This software application provides a complete set of image-processing, measurement, inspection and object finder tools. For more information on vision, refer to the *PreciseVision Machine Vision System, Introduction and Reference Manual* (PN PVS0-DI-S0010).

System Diagram

The PreciseFlex™ G6000 Controller series system block diagram is shown in Figure 2-1. This controller's Remote Front Panel Interface provides the signals required for a 3rd party to implement a Category 3 (CAT-3) safety rated hardware control panel. Alternately, if this level of safety is not required, a hardware Manual Control Pendant or a simple E-Stop button can be directly connected to this same interface. In fact, if a risk assessment determines that no hardware E-Stop is required for the safe operation of the system, the controller can be operated without a hardware E-Stop.

An Ethernet Switch on the controller's CPU board (the HVCPU) permits multiple Ethernet devices to be easily interfaced to the controller. These devices can include but are not limited to: a PC to access the G6000's built-in web based operator interface or to send commands to the controller; other PreciseFlex controllers that can extend the controller's synchronized motion control capabilities using the PreciseFlex Servo Network; external IO including Modbus/TCP devices; and EtherCAT slave nodes.

All of the extensive communication features of the controllers are described in detail in the following sections.

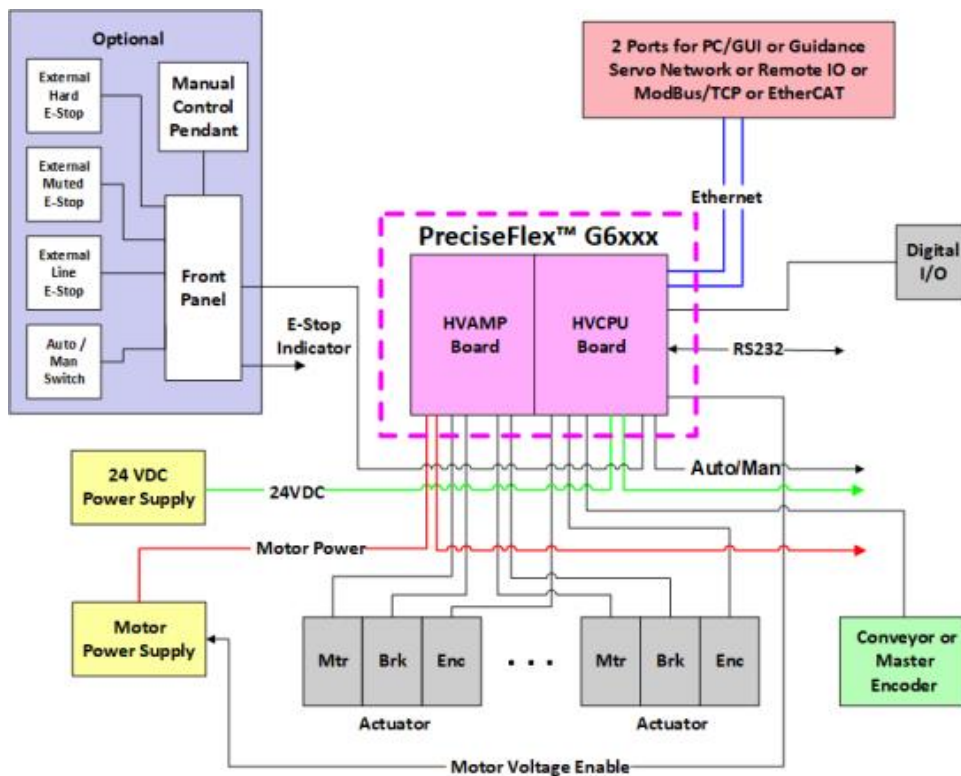

Figure 2-1: PreciseFlex G6000 Controller, System Diagram

System Components

PreciseFlex G6000 Controllers

All PreciseFlex G6000 Controllers include the following:

- 1GHz high performance
- Low power CPU
- At least 128MB of dynamic RAM
- At least 64MB of nonvolatile flash disk for storage of the OS
- Firmware and user program and data
- 32Kbyte of nonvolatile RAM

In addition, these units all include the following standard features:

- Four (4) dedicated encoder inputs
- Four (4) configurable encoder inputs
- Twelve (12) general purpose optically isolated digital inputs
- Eight (8) general purpose digital outputs
- An RS-232 port
- Two (2) 100 Mbit Ethernet ports
- An EC Category 3 (CAT-3) compliant front panel interface with redundant E-stop circuits

The encoder ports support incremental quadrature encoders as well as many types of serial absolute encoders.

Each controller consists of the following:

- A High-Voltage CPU board (HVCPU) that contains all of the logic and peripheral interfaces
- A High-Voltage AMP board (HVAMP) that contains the motor drivers
- A heat sink to dissipate the heat from the motor power amplifier chips.

The HVCPU hardware is standard for all controllers. The HVAMP and sheet metal vary and are a function of the number of integrated motor drivers.

The G6400 models come with four integrated motor drives. As with all G6000 controllers, the drives can control motors that operate at bus voltages between 24VDC and 340VDC. The total motor power output of the controller is a function of the motor power supply and the size of the heat sink on which the controller is mounted plus any forced air cooling. The PreciseFlex G6400 can provide 10A, 20A, or 33.3A peak current to each motor and is shown in [Figure 2-2](#).



 DANGER Electrical Shock	
<p>The PreciseFlex Controllers are open frame electrical devices that contain unshielded high voltage pins, components and surfaces. These products are intended to be mounted in a cabinet or machine chassis that is not accessible when AC line power is turned on.</p>	



Figure 2-2: The PreciseFlex G6400

For applications that require 6-axes, the G6600 provides six motor drives. The drives are rated at a mixture of peak currents in order to address both larger primary axis motors and smaller end-of-tool motors. This unit has a somewhat larger HVAMP board and sheet metal and is shown in [Figure 2-3](#).





Figure 2-3: The PreciseFlex G6600

All PreciseFlex Controllers can be networked with other PreciseFlex Controllers to drive even more axes or if it is desirable to physically distribute controllers to simplify wiring.

Low-Voltage Power Supply



The PreciseFlex Controllers require 0.7 Amps of 24VDC power for its logic circuits and 2 Amps for IO power, for a total of 2.7 Amps. An additional Amp is required if this supply also drives the contactors on the motor power supply. For applications using remote IO, PreciseFlex recommends a total of 5 Amps. This voltage may be supplied by a user power supply or an off-the-shelf 24VDC power supply.

A commercially available 120 Watt, 24VDC Power Supply, Mean Well P/N EPS-120-24, with AC input from 80V to 264V, is shown below.

 DANGER Electrical Shock	
The illustrated 24VDC logic power supply is an open frame electrical device that has exposed unshielded high voltage pins, components and surfaces. In addition, the heat sinks on the 24VDC Power Supply are not grounded and expose high voltage levels. This product is intended to be mounted in a cabinet or machine chassis that is not accessible when AC line power is turned on.	

Intelligent Motor Power Supplies

The PreciseFlex G6000 Controllers operate with motor voltages from 24VDC to 340VDC. Brooks offers three power supplies that are compatible with these controllers: the PrecisePower 300, 1000 and 2000 Intelligent Motor Power Supplies. These units include: integral relays for enabling/disabling motor power on command from the controller, large value output filter capacitors to store deceleration energy for use when power is needed, the ability to absorb line spikes, and built-in fuses.

 DANGER Electrical Shock	
The PrecisePower Intelligent Motor Power Supplies are open frame electrical devices that have exposed unshielded high voltage pins, components and surfaces. In addition, these power supplies provide 320VDC volts and take several minutes to bleed down after power is disconnected. These products are intended to be mounted in a cabinet or machine chassis that is not accessible when AC line power is turned on.	

The PrecisePower 300 is a 300/600 watt power supply that accepts 90 to 264 VAC 50/60 Hz and generates a nominal output of either 160VDC or 320VDC depending on the input voltage. This unit includes a single integral relay for enabling and disabling motor power on command from the controller.



Figure 2-4: The PrecisePower 300

As a rule-of-thumb, 600 watts from the power supply can normally drive motors with a total rating of approximately 2400 Watts. This is because motor power ratings are typically defined by the "rated torque" that can be supplied at the "rated speed" of a motor. However, in most robotic applications, high torque is only required at low speed. For example, the PrecisePower 300 has successfully driven a Cartesian robot at full speed where the sizes of its four motors were 750W, 400W, 200W and 100W (1450W total).

The PrecisePower 1000 (shown below) is a 1000 watt power supply that accepts 90 to 264VAC 50/60 Hz and generates a nominal output of either 160VDC or 320VDC depending on the input voltage. This unit includes a single integral relay for enabling and disabling motor power on command from the controller. As with the PrecisePower 300 power supply, this unit does not include the full safety controls necessary to satisfy CAT-3 requirements.



Figure 2-5: The PrecisePower 1000

For applications requiring a higher power intelligent motor power supply, the PrecisePower 2000 (shown below) delivers 2000 watts from a single-phase 208VAC service or 3400 Watts from a three-phase 240VAC service. This unit includes dual integrated relays for enabling and disabling motor power on command from the controller. In addition, it has safety circuits to automatically shut

down the unit if it is switched to a short or is severely over-loaded. If needed, this unit can be configured to satisfy CAT-3 safety requirements.



Figure 2-6: The PrecisePower 2000

Remote Front Panel, E-Stop Box, and Manual Control Pendant

If an application requires a Category 3 rated front panel, the PreciseFlex G6000 controllers provide the signals necessary to implement a front panel that can include a high power enable button, an auto/manual keyed selector switch, an E-Stop button, and connectors for user E-Stops and interlocks. These signals are all available in the Remote Front Panel interface. However, if this level of safety is not required, the controller can operate without a front panel. When a front panel is not utilized, the following pins on the Remote Front Panel connector must be jumpered. (All controllers are shipped with these jumpers installed.)

1-2, 3-4, 5-6, 7-8, 9-10, 11-12, 13-14

For users that want to have an E-Stop button for their controller without a remote front panel, Brooks sells an E-Stop Box with a connector pigtail that plugs into the Remote Front Panel connector and includes the necessary jumpers.



Figure 2-7: E-Stop Button

For users who want to have a Manual Control Pendant (MCP) that can be carried around the workcell, Brooks offers two hardware MCPs. The standard unit weighs 0.567 kg and includes an E-Stop button. For those applications where an operator must be inside the working volume of a non-collaborative robot while teaching, an alternate teach pendant with an E-Stop button and a 3-position hold-to-run button is also available. The Brooks MCPs come with a 25-pin DSub connector that directly attaches to some PrecisePlace and PreciseFlex robots and Guidance Systems. A 25-pin DSub to 20-pin IDC connector adaptor cable is available for plugging a MCP into the Remote Front Panel connector of a PreciseFlex G6000 Controller. As with the E-Stop Box, the PreciseFlex MCP connector includes the necessary jumpers for the proper operation of the controller.



Figure 2-8: Manual Control Pendant

Remote IO Module

For applications that require additional IO capability beyond the standard functions provided with every PreciseFlex Controller, a Brooks Remote IO (RIO) module may be purchased. The RIO interfaces to any PreciseFlex Controller via 100 Mbit Ethernet and requires 24VDC power.

The RIO includes:

- 32 isolated digital input signals
- 32 isolated digital output signals
- One RS-232 serial line

Up to four RIOs can be connected to a controller.

The RIO module is pictured in [Figure 2-9](#).



 WARNING	
<p>The RIO contains unshielded 24VDC signals and pins. This product is intended to be mounted in a cabinet or machine chassis that is not accessible when power is turned on.</p>	



Figure 2-9: RIO Module

Machine Vision Software and Cameras

All PreciseFlex Controllers support the PreciseVision machine vision system. This is a vision software package that can run either on a PC for higher performance applications or an embedded vision processor for simpler applications (available soon).

PreciseVision communicates with the motion controller via Ethernet and with cameras via either Ethernet or USB connections. Vendors such as IDS Imaging offer a variety of Ethernet machine vision cameras and industrial USB cameras.

Status LED and Status Output Signal

The G6000s include a Red/Green Status LED on their top (HVCPU) board that indicates the execution state of the controller. As a convenience, if the controller is embedded and the Status LED is not visible, the execution status can also be displayed by an external binary LED that is wired to the Status Output On/Off Signal Connector.

To configure the Status Output Signal Connector or any general-purpose digital output to serve as a status indicator, the "Power State DOUT" (DataID 235) must be set equal to the signal's GPL channel number.

The execution conditions that are indicated by the LED and the output signal (if configured) are described in [Table 2-1](#). If Red or Green is not indicated as being on, they are off.



Table 2-1: Execution Conditions Indicated by LED and Output Signal

LED State	Status Signal	System Status	Description
Off, never on or blinking	Off, never on or blinking	Logic power off	Normally indicates that 24VDC logic power is off.
Green on, not blinking	Off, never on or blinking	Boot code loading software and firmware	Typically indicates that 24VDC logic power is on and the controller is executing its startup boot sequence. The Status Signal is off since the PAC files that control the Status Signal are being loaded.
Green blinks 1 time per second	Blinks 1 time per second	Normal operation, motor power off	The controller is executing in its standard operating mode and motor power is disabled.
Green blinks 4 times per second	Blinks 4 times per second	Normal operation, motor power on	The controller is executing in its standard operating mode and motor power is enabled.
Green blinks 8 times per second	Blinks 8 times per second	CPU overheating	The processor is overheating, motor power is off, and the user has 5 minutes to save any programs or data. After 5 minutes, the processor will shut down and needs to be rebooted.
Off, Green formerly blinking	Off, formerly blinking	Safety diagnostics failed	In rare instances, the green LED and the Status signal will be blinking for a period of time, but when a user attempts to enable motor power, both are turned off. This indicates that the robot's safety checks failed and the robot is not safe to operate.
Red on, not blinking	On or off, not blinking	CPU crashed	This rarely occurs and indicates that the controller has crashed due to a system hardware or software error.

Machine Safety

Voltage and Power Considerations

The PreciseFlex G6000 Controllers require two DC power supplies: a 24VDC power supply for the logic and user IO, and a separate motor power supply. The motor power supply must provide the controller with a voltage between 24VDC and 340VDC.

 DANGER Electrical Shock	
<p>The PreciseFlex G6000, the PrecisePower Intelligent Motor Power Supplies, and the 24VDC power supply are all open frame electrical devices that contain unshielded high voltage pins, components and surfaces. These products are intended to be mounted in a cabinet or machine chassis that is not accessible when AC line power is turned on.</p>	

Brooks offers three Intelligent Motor Power Supplies: the 300/600 Watt PrecisePower 300 with an input range from 90 to 264VAC 50/60Hz, the 1000 Watt PrecisePower 1000 with an input range from 90 to 240VAC 50/60 Hz, and the 2000 Watt PrecisePower 2000 that operates between 90-240VAC single or three phase, 50/60Hz. These motor power supplies contain relays that permit the controller to enable and disable motor power. The PrecisePower Intelligent Motor Power Supplies limit inrush current to approximately 6 Amps. They are protected against voltage surge to 2000 Volts by means of MOVs at the line input. Transient over voltage ($< 50 \mu\text{s}$) may not exceed 2000V phase to ground, as per EN61800-31996. They are protected against over current by 250V fuses. The PreciseFlex controller can monitor motor power through its data logging function. Intermittent power dropouts can be detected by setting a trigger in the data logger which can record and time-stamp power fluctuations.

Enclosure Interlocks

If the PreciseFlex G6000 Controllers and their power supplies are mounted in a cabinet that can be opened without the use of a special maintenance tool, a high power disconnect switch should be connected to the enclosure door, such that when the door is opened, high power is disconnected from the power supplies. The pictures below indicate general areas and connectors on the controllers that have exposed high voltages and therefore pose a very high-risk when motor power is enabled.



 DANGER Electrical Shock	
<p>The surfaces, connectors, and leads in the pictures below that are either red or called out indicate exposed elements of the PreciseFlex G6000 Controllers that carry motor power. Depending upon the motor power supply, the voltage levels can range from 24VDC to 320VDC</p>	

Figure 2-10 illustrates the high-risk areas of the PreciseFlex G6400 4-Axis Controllers.

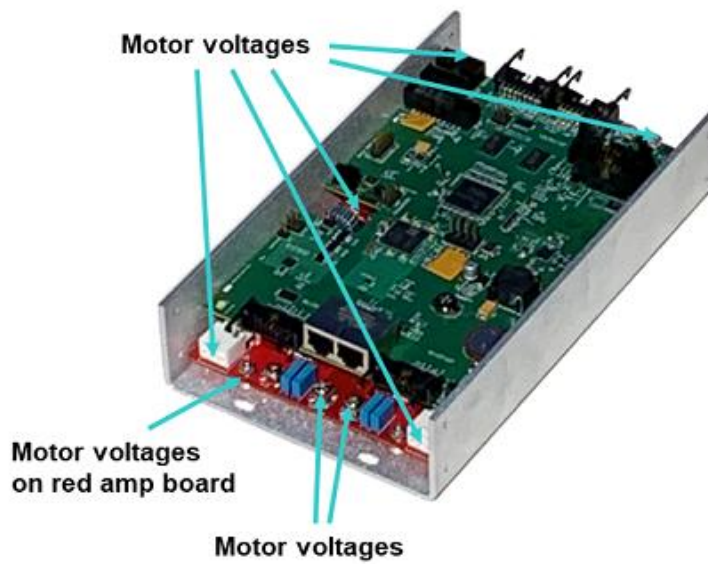

Figure 2-10: High-Risk Areas of the G6400 4-Axis Controllers

Figure 2-11 illustrates the high-risk areas of the PreciseFlex G6600 6-Axis Controllers.

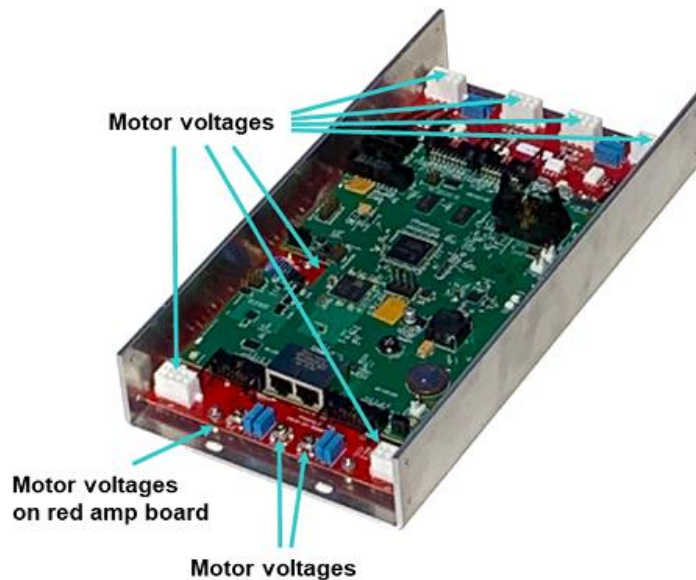

Figure 2-11: High-Risk Areas of the G6600 6-Axis Controllers

E-Stop Stopping Time and Distance

The control system responds to two types of E-stops: "Soft E-Stop" and "Hard E-Stops."

Soft E-Stop

A "Soft E-Stop" initiates a rapid deceleration of all robots currently in motion and generates an error condition for all programs that are attached to a robot. This method can be used to quickly halt all robot motions in a controlled fashion when an error is detected.

This function is similar to a "Hard E-Stop" except that a soft E-Stop leaves motor power enabled and is therefore applicable to less severe error conditions. Leaving motor power enabled is beneficial in that it prevents the robot axes from sagging and does not require motor power to be re-enabled before program execution and robot motions are resumed. This method is similar to a "Rapid Deceleration" except that a Rapid Deceleration only affects a single robot and no program error is generated.

Hard E-Stop

A "Hard E-Stop" is generated by any one of several hardware E-Stop inputs and causes motor power to be disabled. However, there is a firmware parameter that can delay opening the motor power supply relay for a fixed amount of time after a hard E-Stop signal is asserted. This delay is nominally set at 0.5 seconds and may be adjusted by an operator with administrator privileges. On

the web-based operator interface menu, go to **Setup** → **Parameter Database** → **Controller** → **Operating Mode** and set parameter DataID 267 to the desired delay. If this delay is set to 0, the motor power relay will be disabled within 1ms after an input signal is asserted.

If an axis does not have a mechanical brake and motor power is disabled while the axis is moving, it may coast for a significant distance. Leaving the motor power enabled for 0.5 sec allows the servos to perform a rapid controlled deceleration of these axes. For example, if a linear axis is moving at a speed of 1000 mm/sec and the servos decelerate it at 0.4G (3920 mm/sec²), the axis will reach a full stop in 0.26 sec after having only traveled a distance of 127 mm.

If a gravity loaded axis has a mechanical brake but the brake takes some time to engage, if motor power is disabled immediately when a Hard E-Stop is signaled, the axis will drop before the brake takes effect. In this case, delaying for a short period of time before disabling motor power allows time for the brake to engage and prevents the axis from dropping.

Safety Zones

For all robot types, “Safety Zones” can be defined that disable motor power and halt the motion of the robot if its tool center point (TCP) violates the requirements of a user defined 3D volume.

Types of Safety Zones

These 3D safety zones can be used to:

1. Approximately model the volume of stationary objects or personnel working areas to prevent the robot from inadvertently entering this volume and causing a collision (“keep out zones”).
2. Reduce the normal working volume of the robot to prevent the robot from reaching beyond prescribed boundaries and causing a collision (“stay within zones”).
3. Verify that the robot’s TCP speed (when in a specified volume) is below a specified limit so that the robot can be safely decelerated and stopped before it might pin an operator’s hand to a hard surface with too high a force (“speed restrict zones”).

As currently implemented, the “keep out zones” and “stay within zones” are provided as general safety features, but they do not meet the stringent Category 3 safety standards that require fail safe redundant logic. However, the “speed restrict zones” do provide the requisite redundancy and are in the process of being Category 3 certified. The “keep out zones” and “stay within zones” are collectively referred to as “uncertified zones” and the “speed restrict zones” are referred to as “certified zones”.

The supported zone shapes are rectangular volumes, cylinders and spheres. To define a safety zone, the type of safety zone must be specified along with its origin and dimensions.

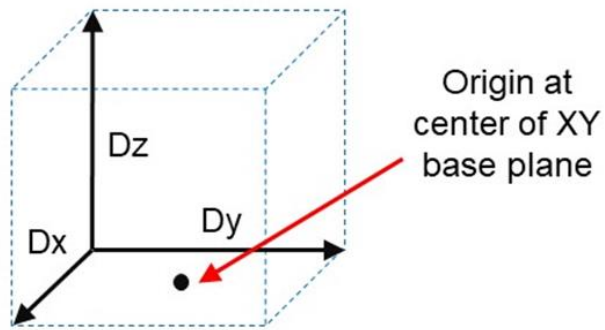

Figure 2-12: Rectangular Volume

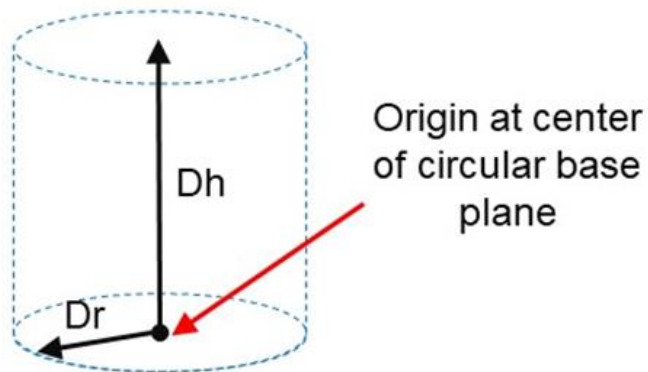

Figure 2-13: Cylinder

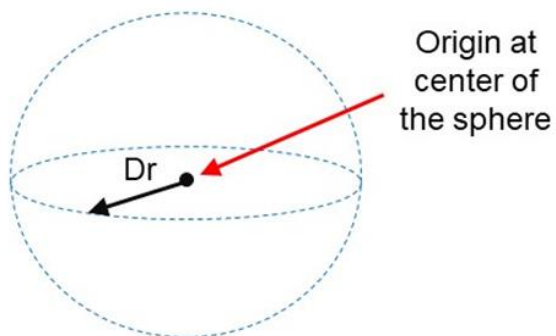

Figure 2-14: Sphere

For increased generality, uncertified zones can be arbitrarily positioned and rotated in all three dimensions. Due to implementation limitations, certified zones must be non-rotated rectangular volumes, which can be arbitrarily positioned. Up to 10 zones can be defined for each robot and any mix of certified and uncertified can be specified. Due to safety requirements, any new or modified zone specifications only go into effect after the controller is rebooted.

Safety Zone Violation Detection and Clearing

Uncertified safety zones are active in the following circumstances:

- Continuously during program-controlled motions of all types (straight line or arc Cartesian and joint interpolated).
- Continuously during manual (jog) control modes: World, Tool and Joint, but not free.
- Motion planning (final destinations only).
- Location object.KineSol method during conversions to either Cartesian or joint Locations.

Certified safety zones are only active during program-controlled motions (of all types) since this is the only circumstance where higher TCP speeds are possible.

When motor power is enabled and the robot's TCP is in violation of an uncertified safety zone, a program-controlled motion cannot be initiated. This condition can be cleared by disabling motor power and manually repositioning the robot or by manually jogging the TCP in World, Tool or Joint modes, so long as the jog motion reduces the safety zone violation distance. That is, jogging motions that increase the violation of a safety zone are not permitted.

NOTE: Safety zone testing is based on the TCP of the robot. Therefore, it is very important that the position of the tool center point relative to the robot's tool mounting flange is set correctly. Please see the Robot.Tool property for information on defining the TCP.

Certified Speed Restrict Safety Zones

While the uncertified safety zones perform conventional tests on just the position of the TCP, there are two certified safety zones and these perform special tests to detect if the speed of the TCP exceeds a limit while the TCP is within the zone. The first certified safety zone tests if the Z downward speed of the TCP exceeds a specified limit. This safety zone was implemented for the PreciseFlex 400 and PreciseFlex 3400 robots since their only intrinsically non-safe motion is a high-speed downward Z motion that could trap a person's hand between the tooltip and a fixed object or horizontal surface. The second certified safety zone tests if the horizontal, XY planar, speed of the TCP exceeds a specified limit. This test was developed for the PreciseFlex™ DD robots since robots can generate excessive speeds when moving horizontally.

For both of these tests, in order to satisfy the computational redundancy requirement of the Category 3 safety regulations, the shapes of these safety zones are limited to non-rotated rectangular volumes.

Please consult the user manuals for these PreciseFlex™ robots for when speed restrict safety zones must be defined to safely operate these mechanisms.

Configuring Safe Zones

Up to 10 safety zones can be defined per robot. Each of these zones is specified by filling in one of the Parameter Database IDs 16900 to 16909, which are labeled "Safety Zone: type, x/y/z/y/p/r, dim 1/2/3". Any combination of certified and uncertified safety zones can be specified. Each of these DataIDs consists of an array of 10 numbers and the first value defines the safety zone "type". Any DataID that has a zero "type" is ignored. [Table 2-2](#) describes the possible safety zone types:

Table 2-2: Safety Zone Types

Safety Zone Type	Description
0.	Undefined safety zone
1.	Rectangular volume, keep out zone
2.	Cylinder, keep out zone
3.	Sphere, keep out zone
4.	Rectangular volume, stay within zone
5.	Cylinder, stay within zone
6.	Sphere, stay within zone
7.	Non-rotated rectangular volume, Z downward speed restrict zone
8.	Non-rotated rectangular volume, XY speed restrict zone

[Table 2-3](#) describes the safety zone DataIDs. When any of these DataIDs are modified, the controller must be rebooted for the change to be put in effect.

Table 2-3: Data IDs

DataID	Parameter Name	Description
16900 to 16909	Safety Zone: type, x/y/z/y/p/r, dim 1/2/3	<p>Each safety zone definition consists of an array of 10 values. The first value is the safety zone “type”. The next six values define the position of the origin of the volume of interest and its orientation. This is specified as a standard Location value:</p> <p style="text-align: center;">x, y, z, yaw, pitch, roll.</p> <p>The final three values define the size of the volume of interest. For the permitted shapes, this is interpreted as:</p> <p style="text-align: center;">volume: Dx, Dy, Dz Cylinder: Dh, Dr, 0 Sphere: Dr, 0, 0</p> <p>For example, for a downward Z non-rotated rectangular volume speed restrict safety zone, a single DataID should be specified as follows:</p> <p style="text-align: center;">7, x, y, z, 0, 0, 0, Dx, Dy, Dz</p> <p>Where x, y, z are the coordinates of the center of the base of the rectangular volume and Dx, Dy, Dz are the dimensions of the volume, all in mm.</p>

In addition, the DataID in [Table 2-4](#) must be initialized to establish the maximum speed limits for the certified safety zones:

Table 2-4: Data IDs

DataID	Parameter Name	Description
2740	Certified safety zone, max Z/XY spd mm/sec	<p>These parameters define the maximum speeds that are permitted for the Certified Speed Restrict Safety Zones. The first value is the maximum downward Z speed (when within the safety zone) in mm/sec. Since this is a downward speed, it should be a negative value and defaults to -200. The second value is the maximum permitted speed in the horizontal XY plane (when within the safety zone), and defaults to 200 mm/sec.</p>

Safety Standards Reference Material

PreciseFlex Controllers can operate computer-controlled mechanisms that are capable of moving at high speeds and exerting considerable force. Like all robot and motion systems and most industrial equipment, they must be treated with respect by the user and the operator.

This manual should be read by all personnel who operate or maintain Brooks systems, or who work within or near the work cell.

Read the *American National Standard for Industrial Robot Systems – Safety Requirements*, published by the Robotic Industries Association (RIA) in cooperation with the American National Standards Institute. The publication, ANSI/RIA R15.06, contains guidelines for robot system installation, safeguarding, maintenance, testing, startup, and operator training. Also read the International Standard IEC 204 or the European Standard EN 60204, *Safety of Machinery – Electrical Equipment of Machines*, and ISO 10218 (EN 775), *Robots for Industrial Environments – Safety Requirements*, particularly if the country of use requires a CE-certified installation.

Standards Compliance and Agency Certifications

PreciseFlex Controllers are intended for use with other equipment and are considered a subassembly rather than a complete piece of equipment on their own. When installed in a suitable enclosure with proper grounding and cable design, they meet the requirements of the following standards:

- EN 61000-4-2 Electrostatic Discharge (8KV air, 6KV contact)
- EN 61000-4-3 Radiated Electromagnetic Field Immunity (3V/m, 27-500 MHz)
- EN 61000-4-4 Electrical Fast Transient/Burst Immunity (2KV)
- EN 61000-4-5 Surge Immunity Test (1KV differential, 2KV common mode)
- EN 61000-4-6 Conducted Disturbances Immunity (RF: 150KHz – 80MHz)
- EN 50081-2 Electromagnetic Compatibility General Emissions Standard

To maintain compliance with the above standards the controller must be installed and used in accordance with the regulations of the standards, and in accordance with the instructions in this user's guide.

In addition to the above standards, PreciseFlex Controllers have been designed to comply with the following agency certification requirements:

- CE
- CSA
- UL
- ANSI/RIA R15.06 Safety Standard

Moving Machine Safety

PreciseFlex Controllers drive robots that can operate in Manual Control Mode, in which an operator directly controls the motion of the robot, or in Computer Control Mode, in which the robot operation is automatic. Manual Control Mode is often used to teach locations in the robot workspace. The robot's speed should be limited in Manual Control Mode to a maximum of 250 mm/sec for safety as required by EN ISO 10218-1-2011.

This speed setting can be easily confirmed using the "Virtual Pendant" in the Web interface. After enabling power and homing the robot, select "Virtual Pendant" in the Web Control Panels Menu, then select a manual control mode such as **World Mode**, select the **X-axis**, set the speed slider to 100%, drive the axis 250 mm, and time the motion. While it is possible to set a high manual control speed, this is not recommended, and should only be done after an application risk assessment.

While some light-duty robots (like the PrecisePlace) can only apply moderate forces, it is always very important for operators to keep their hands, arms and especially their head out of the robot's operating volume.

In Computer Mode, robots can achieve speeds over 2000 mm/sec. During Computer Mode Operation it is strongly recommended that operators be prevented from entering the robot work volume by safety barriers that are interlocked to the E-stop circuitry. Refer to the ANSI/RIA R15.06 *Safety Standard for Industrial Robots* or EN ISO 10218-2-2011, *Robots for Industrial Environments, Safety Requirements*, for information on recommended safe operating practices and enclosure design for robots of various sizes and payloads.

3. Installation Information

Heat Sinking and Mounting

The mounting holes for the 4-axis PreciseFlex G6400 are shown in [Figure 3-1](#), where all dimensions are in units of millimeters.

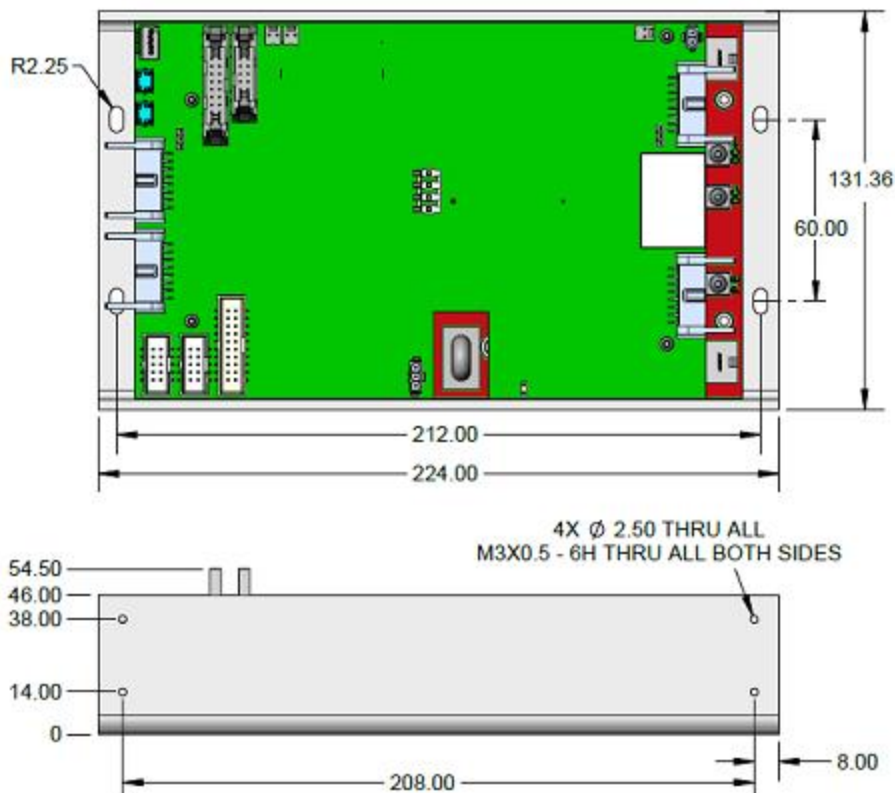

Figure 3-1: Mounting Holes for the Four-Axis G6400

The PreciseFlex G6000 sheet metal heatsink must be attached to an external heatsink for proper operation. The size of the heatsink depends on the total motor power. Note that total motor power is NOT the same as adding up all the rated powers of the motors. It is typically about 30% of this value,

as each robot joint accelerates from zero to some velocity and back to zero. It is useful to install a power meter between the controller and the AC power source to measure the real average power during a typical robot cycle.

For 500 Watts RMS total motor power, the external heatsink should be a plate that is approximately 2.3 mm thick with a surface area of 0.10 m². For 1000 Watts, the heatsink should have a surface area of approximately 0.20 m². For 2000 Watts, a fan should typically be added to the heatsink. The fan should be at least 60 mm square and provide a minimum of 40 CFM of air blowing axially through the controller. The heatsink surface area is very important for effective heat dissipation, but the thickness of the plate can be reduced if necessary.

The controller should be mounted to the external heatsink with thermal grease and either M4 or 8-32 screws. Figure 3-2 illustrates the mounting holes and dimensions in millimeters for the 6-axis PreciseFlex G6600.

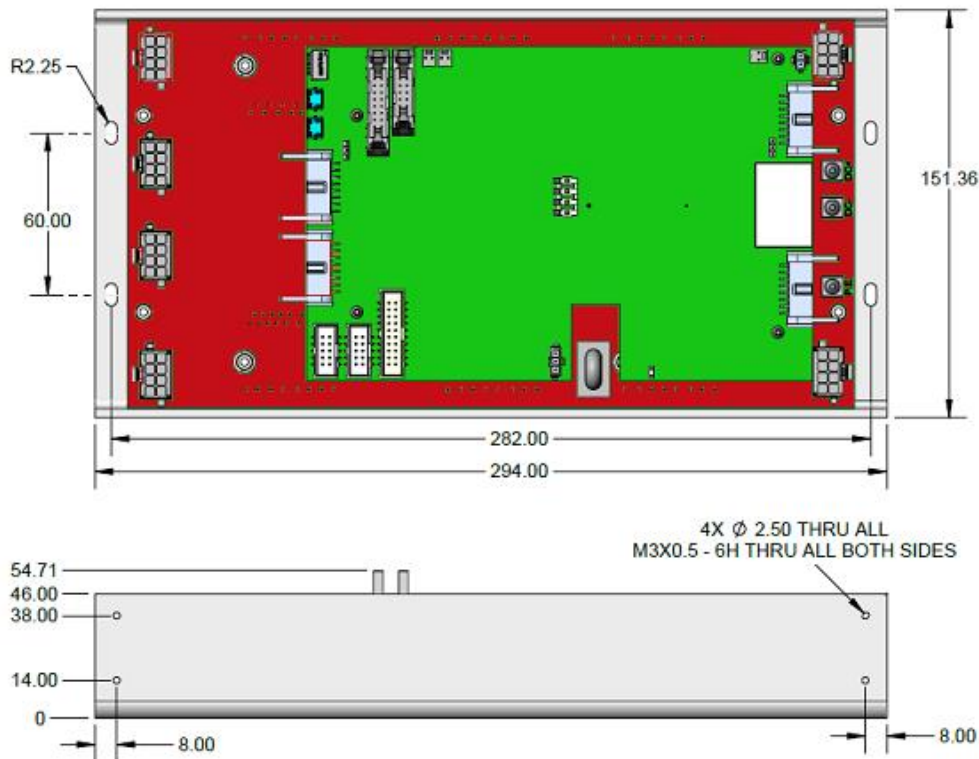

Figure 3-2: Mounting Holes for the 6-Axis G6600

A good indication of whether the controller is being properly cooled is to monitor the CPU and amplifier temperatures after the system has operated for an hour or two at its full speed and load. These temperatures can be read via the Web interface **Control Panels > System Information > System Console > Amp Temp**. For long-term reliable operation, the CPU temperature should be 80° C or lower and the amplifier temperatures should be 80° C or lower. If the current ambient temperature is below the expected maximum operating temperature, add the difference between the current ambient and the maximum ambient to estimate the maximum temperatures. For

example, if the current ambient temperature is 25° C and a user expects to operate at the system's maximum ambient of 40° C, add 15° C to the readings of the CPU and amplifier temperatures to determine if the cooling is sufficient. For applications with high duty cycles and high power or limited heat sinking or high ambient temperatures, a small fan blowing through the controller will greatly reduce the controller's operating temperature.

Recommended Motor and Encoder Wiring

Wiring Overview

With the pressure to design high power motor drive electronics with low power losses, switching motor drive amplifiers now have PWM edges that switch 400 Volts as fast as once every 100 ns. While this helps to keep switching losses down, it has made receiving logic level signals from encoders and sensors very difficult. This is because every PWM edge must charge and discharge the motor wiring capacitance. The current spikes to do this can be as large as 4 Amps. This current flow causes the motor frame to have ground bounce on it due to the inductance of the ground return back to the amplifier. This ground bounce and the coupling between motor and encoder harness wires can introduce noise into the system. This section describes wiring techniques that will reduce the interference between motors and encoders.

NOTE: For systems that operate with a 48 V or lower motor bus, the ferrite beads and the 600 V wire that are described in the following sections are not needed.

It is very important that the wiring guidelines in this section be followed in order to avoid encoder quadrature errors, zero index errors, data transmission errors in high frequency serial absolute encoders, communication failures and other noise related problems.

Motor Cables

The following table presents the current ratings for typical three conductor cables with PVC insulation rated at 105° C and with an ambient temperature of 30° C as a function of the wire size. In general, the wire ratings should meet or exceed the RMS (rated) current of the motor and not the peak current since the primary concern is over-heating the wire due to excessive average motor currents. The current ratings for single conductor cables are higher, although multiple conductor cables are more commonly used.

Table 3-1: Cable Ratings

Wire Size AWG	24	22	20	18	16	14	12	10
Amperes	2	3	5	7	10	15	20	30

The **motor wire should always be shielded** and have a rating of 600 volts (except for 48 VDC motor bus voltages and below). The typical wires that are shown in the table below have a 105° C rating. These wires do not have a drain wire, so a drain connection must be soldered to the shield.

Table 3-2: Wires with a 105° C rating

	Alpha 16 AWG	Alpha 18 AWG	Beldon 16 AWG	Beldon 20 AWG
High Flex	85603CY	85803CY		
Moderate Flex	65603CY	65803CY		
No Flex	3247	3242	9953	9963

Motor Wiring Path

If the motor frame and the amplifier heat sink are less than 0.5 meter apart and share the same metal chassis, use shielded wire without a shield ferrite bead. (“Ferrite beads” are sometimes referred to as “ferrite chokes” or “ferrite cores.”) In this case, the ground bounce of the motor will be small due to the short distance and the shared chassis. The shield must be connected to the amplifier at pin 5 and at the motor end, to the motor frame. [Figure 3-3](#) illustrates how this cable should be wired.

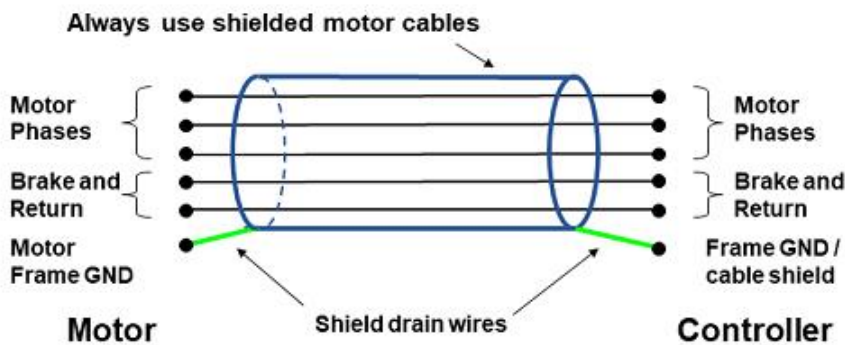

Figure 3-3: Wiring Illustration, Short Cable. Motor and Controller Less Than 0.5 M Apart with Common Chassis

If the distance is more than 0.5 meter, use a shield bead around the motor phase wires at the amplifier end of the harness to reduce the charging current spikes. The phase wires as a group must pass through the bead core three times. The ground or brake wires must NOT pass through the bead core.

Another special consideration is if there is no chassis between motor and amplifier, the length of the shield drain wire must be kept as short as possible, probably no more than 25 mm at the amplifier connector end of the cable and no more than 70 mm at the motor end. This will cause the bead to be adjacent to the shield, in order to keep drain wire short.

Figure 3-4 illustrates how this cable should be wired.

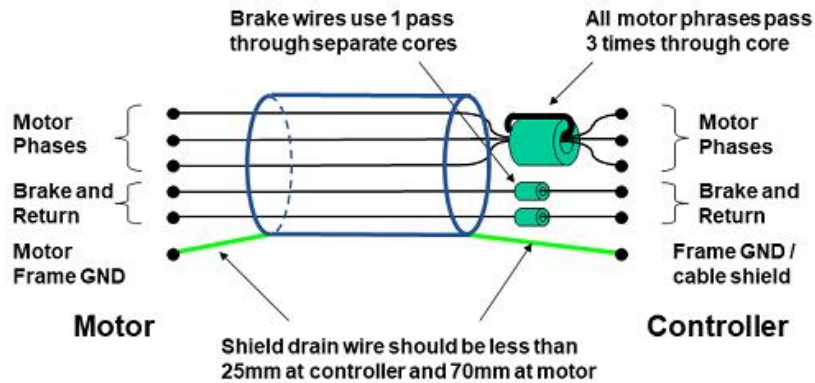

Figure 3-4: Wiring Illustration, Long Cable. Motor and Controller Greater Than 0.5 M Apart without Common Chassis

Motor Ferrite Beads

Based upon the wire and insulation thickness, [Table 3-3](#) lists the typical ferrite cores that can be utilized.

Table 3-3: Ferrite Cores

Wire and Insulation Thickness	Ferrite Bead
Wires up to 1.5 mm	FAIR-RITE #2631540002
Wires up to 2.9 mm	FAIR-RITE #2631102002

Thermal rises of up to 40° C in the bead temperatures are acceptable. However, if the bead gets hotter, use the next size core of material 31 or one less turn through the bead. Never use more than three turns through the core to avoid diminishing the effectiveness of the ferrite. This is caused by adjacent wires capacitively coupling and passing the spikes through the core.

The effectiveness of the cores can be determined with a current probe with a window large enough to pass all the motor phases of the motor in question through the probe in the same direction. Put the probe on the amplifier side of the harness. This will measure the common mode ground current. Use just enough turns to reduce the amplitude of the current spike without causing any additional ringing. Usually a user can achieve a 30-50% reduction in the spike amplitude.

Brake Wiring

If the brake wires are in the shielded cable with the motor wires, then a separate bead must be used for each brake wire at the controller side of the harness. Use FAIR_RITE # 2673021801. One wiring pass straight through the bead is adequate.

Ferrite Bead Installation Illustration

The following series of pictures illustrate the process of installing a ferrite bead onto the harness at the controller end of the motor cable. In the first picture, the dark blue wire is the shield drain wire that has already been soldered to the shield. The shield was then covered with shrink tubing. This example also shows the optional beads on the brake wires.

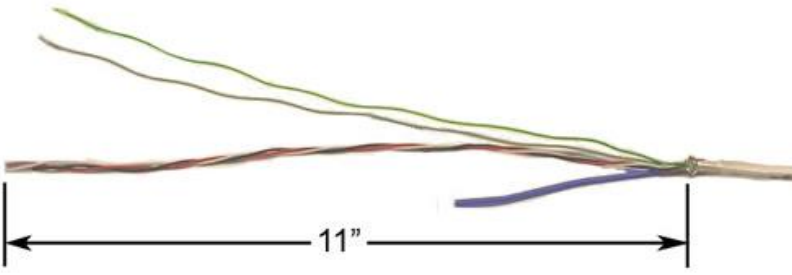
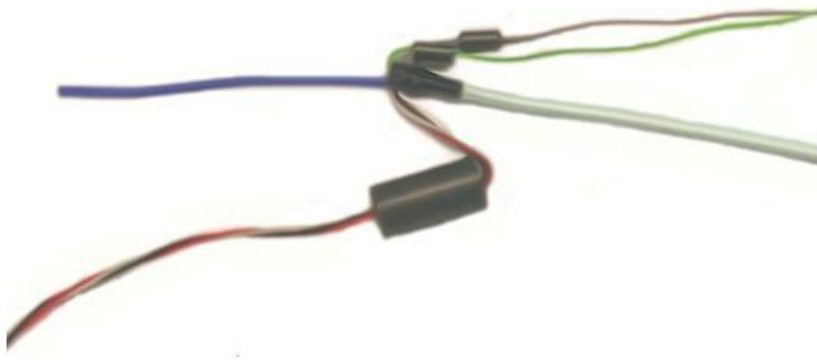
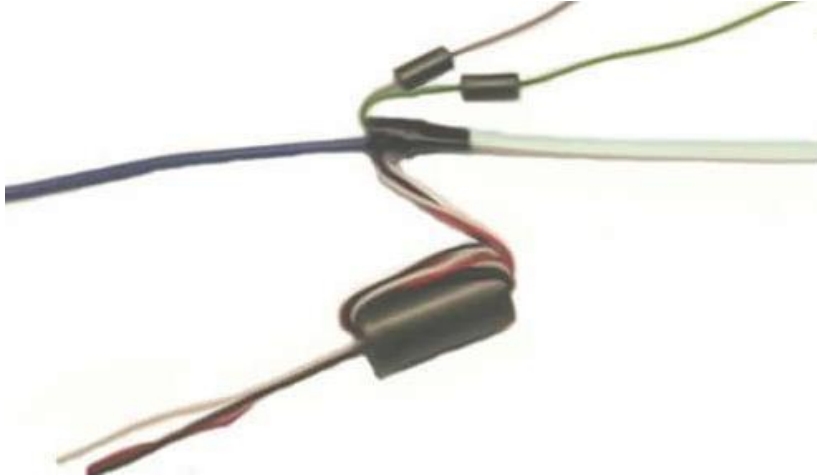
Step	Action
1.	 <p>Blue drain soldered to shield and wires cut to length</p>
2.	 <p>Three (3) motor wires through large core, brakes through small cores</p>
3.	 <p>Three (3) motor wires looped three times through large core</p>

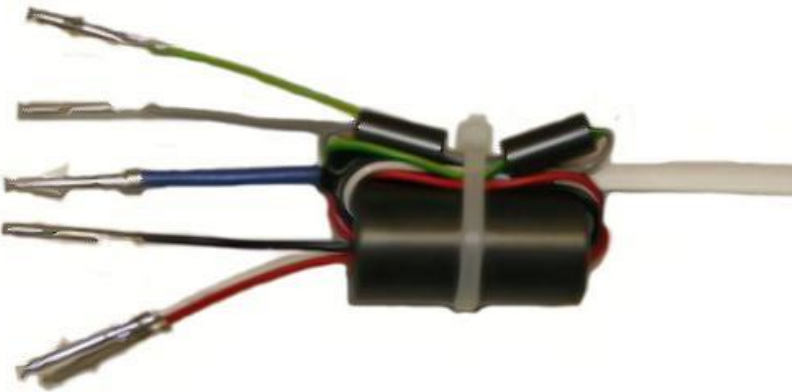
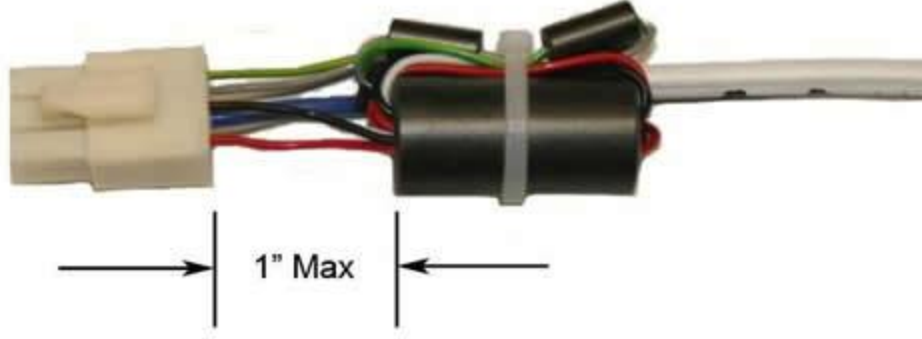
Step	Action
4.	 <p>All wires leads crimped to pins</p>
5.	 <p>Final assembled cable with controller motor connector</p>

Encoder Considerations

The preferred encoder should have a differential cable driver built in. The differential signal will cancel out much of the common mode noise that encoder wiring can pick up and, when used with twisted pair wire, will cancel out the magnetic pick up from the motor harness.

Some encoders have an open collector output or an output with only a 10K pull up resistor. These encoders should only be used with a cable driver IC such as a DS26C31 mounted nearby the encoder or the encoder should be mounted within 5 feet of controller and wired with shielded cable.

If an encoder's code wheel or linear mask is made with etched metal or other conductive material, the encoder should not be used if it is mounted to any housing or chassis that has ground bounce on it. For example, if such an encoder is directly mounted to a motor frame without electric insulation, its use could result in quadrature errors and other noise problems.

Encoder Cables

It is highly recommended that the encoder cable be shielded and contain 4 twisted pairs with a gauge of AWG 24 or AWG 26. See [Table 3-4](#) for recommended cables.

NOTE: Unshielded non-twisted pair encoder wiring should never be run next to unshielded motor wiring or other sources of noise.

Table 3-4: Recommended Cables

	Alpha 24 AWG	Alpha 26 AWG	Beldon 24 AWG	Beldon 26 AWG
High Flex	86604CY	86504CY		
No Flex	5494C 5272C		88104	

One of the twisted pairs should be used for power and ground, one pair for A+ & A-, one pair for B+ & B-, and one pair for Z+ & Z- (See the next section for specific pin assignments). Connect the shield to pin 7 on the HVCPU encoder connector. For encoders that are in a metal box with a metal shell connector, on the encoder end of the cable, connect the shield to the metal shell of the mating connector.

Encoder Wiring and Pin Assignments

The encoder connectors on the HVCPU board can each be cabled to a differential encoder and an optional single-ended encoder. If a single-end encoder is not interfaced, these pins can be configured for use with hall effect sensors or end-of-travel/home switches. Whenever possible, the differential encoder inputs should be used instead of the single-end encoder inputs to achieve greater noise immunity.

If only a single-end incremental quadrature encoder is connected using twisted pair wire, the low side of both ends of each twisted pair should be connected to ground, and the A-, B-, and Z- signals of the controller's differential encoder inputs should each be pulled to 5V through a 2K resistor. The A+, B+, and Z+ signals should be connected without any special modifications.

If several wires must be connected to a single pin, a larger crimp pin should be used.

NOTE: If crimp style plugs are utilized, ensure that the crimp pins are gold plated and designed for high compression forces. Using tin plated pins or those with low contact forces can result in intermittent signals if there is any movement of the cables.

Especially for high frequency signals, such as those required for serial absolute encoders, it is critical that shielded twisted pair cable be used all the way from the encoder to the controller. Even a 300 mm unshielded non-twisted pair cable from the controller to a bulkhead connector can result in significant signal corruption.

Figure 3-5 illustrates how to interface differential and single-ended encoder input signals.

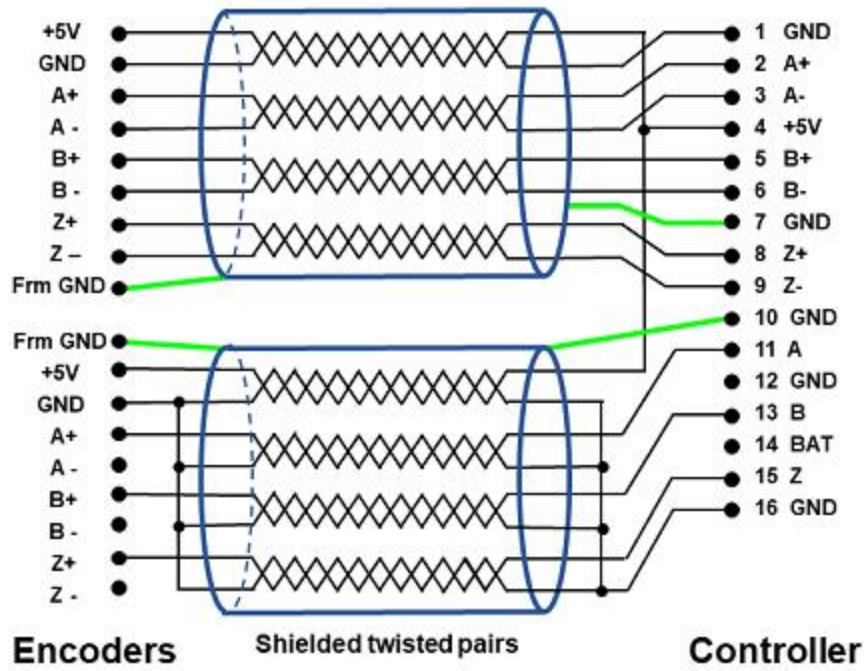

Figure 3-5: Differential and Single-Ended Encoder Wiring

4. Hardware Reference

PreciseFlex™ Controller Assemblies and Interfaces

PreciseFlex Controller Major Assemblies

Each PreciseFlex G6000 Controller consists of two printed circuit board assemblies, a sheet metal heatsink, and assorted hardware. Due to their extremely compact design and the number of device interfaces provided, connectors for services are mounted on both PCB assemblies. The assemblies and the interfaces to other equipment are described in this chapter.

All of the PreciseFlex G6000 Controllers contain the same top PCB assembly, the High Voltage CPU (HVCPU). This board has the CPU chip, the logic functions (such as the FPGA, RAM, flash, NVRAM, etc.) and contains most of the connectors for external communication. The only variability of this board is how the encoder connectors are numbered, as these change between the 4-axis and 6-axis controller in order to align with the motor connectors.

In each controller, the bottom PCB assembly is the High Voltage Amplifier Board (HVAMP). This board contains the integrated motor amplifiers, motor connectors, brake control and other high voltage components necessary to drive motors. There are different HVAMP boards depending upon the current rating of the amplifiers and number of axes supported. To minimize the footprint of the controller, the size of the HVAMP and the sheet metal are a function of the number of amplifiers provided.



 DANGER Electrical Shock	
The PreciseFlex G6000 contains unshielded high voltage pins, components and surfaces. These products are intended to be mounted in a cabinet or machine chassis that is not accessible when AC line power is turned on.	

Figure 4-1w illustrates the primary assemblies of the PreciseFlex G6000 Controller. For clarity, the left edge of the sheet metal heatsink has been graphically removed.

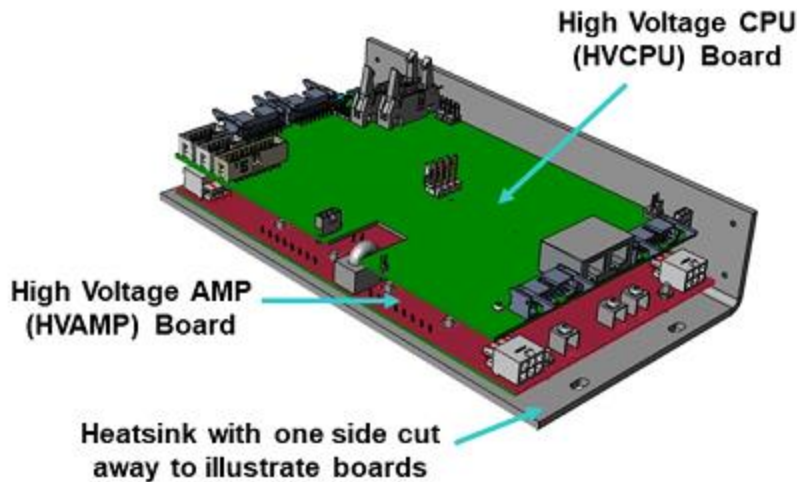



Figure 4-1: The Primary Assemblies of the G6000 Controller

Power Connectors and Grounding

A PreciseFlex G6000 Controller, a PrecisePower Intelligent Motor Power Supply, and 24VDC Power Supply constitute the core components of a high voltage, high power motion control system. The cables necessary to interconnect these primary components are described below.

 DANGER Electrical Shock	
<p>The PreciseFlex G6000's PreciseFlex Motor Power Supply and 3rd party 24VDC power supplies are open frame electrical devices that contain unshielded voltage pins, components and surfaces. These products are intended to be mounted in a cabinet or machine chassis that is not accessible when AC line power is turned on.</p>	

The controller includes a connector (the "Motor Power On/24VDC In") on its top HVCPU board that inputs the 24VDC to power its logic sections and outputs redundant signals that enable and disable the output section of the motor power supply. A pair of screw terminals on the controller's bottom HVAMP board are provided for connecting the +/-DC output of the motor power supply to the controller's integrated motor drives. A third screw terminal is provided on the HVAMP board and must be connected to the AC mains earth ground (green wire) for both safety and to increase the controller's noise immunity. Grounding pads, fastening lugs and screws connect the ground through to the sheet metal heatsink.

The power connectors are shown in [Figure 4-2](#).

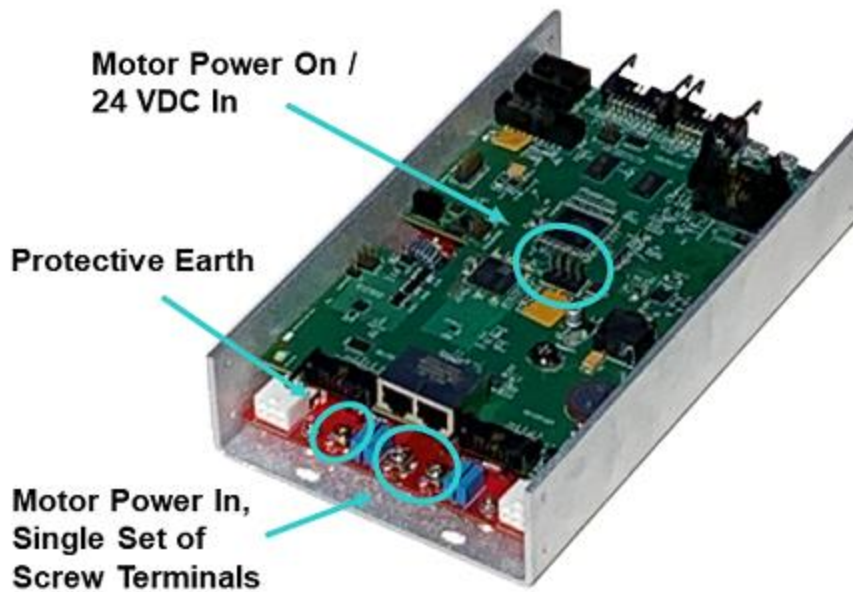

Figure 4-2: G6000 Power Connectors

As a convenience for initial product development, if a user buys a PreciseFlex Controller, a PreciseFlex 24VDC Power Supply, and a PrecisePower Intelligent Motor Voltage Power Supply, the user can also purchase a PreciseFlex Controller Power Harness. This harness provides all of the connections between AC power, the two power supplies and the controller. These power and signal paths are illustrated in solid lines in [Figure 4-3](#).

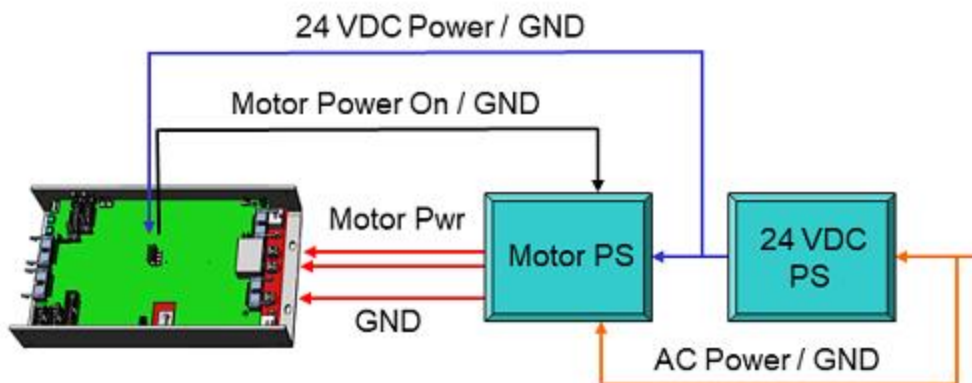





Figure 4-3: PreciseFlex Controller Power Harness

 DANGER Electrical Shock	
<p>For the PreciseFlex G6000 controllers, the 24VDC also provides power to the logic in the Power Amplifiers. If the 24VDC is turned off and motor power remains enabled, the Power Amplifiers will be severely damaged and can cause a hazardous condition.</p>	

Communication Interfaces

HVCPU (High Voltage CPU Board) Interfaces

The HVCPU (High Voltage CPU Board) contains the chips that implement the logic functions of the controller and the connectors that provide interfaces to external equipment. These interfaces are the same for both the four-axis PreciseFlex G6400 and the 6-axis G6600 controllers with the exception that the channel numbers for the encoder interfaces vary to simplify the wiring of motors/encoders. For more information on the encoder channels, see the [HVCPU Board Encoder Interfaces](#).

 DANGER Electrical Shock	
<p>The HVCPU is mated to a High Voltage Amplifier Board (HVAMP) and that board and its Motor/Brake connectors and their leads contain unshielded high voltage pins and circuits. It is intended that the PreciseFlex Controller be mounted in a cabinet or machine chassis that is not accessible when AC line power is turned on.</p>	

The following list defines all of the HVCPU interfaces and hardware facilities:

- [Absolute Encoder Battery](#)
- [COM1, Primary RS-232 Serial Port](#)
- [CPU and FPGA LEDs](#)
- [Digital Inputs DIN 1 Through DIN 12](#)
- [Digital Outputs DOOUT 1 Through DOOUT 8](#)
- [Encoders](#)
- [Ethernet](#)
- [I2C \(not available for general use\)](#)

- MicroSD (not currently implemented)
- [Motor Power-On Enable / 24VDC Controller Power Input](#)
- [Out7 Digital Output Signal](#)
- [Remote Front Panel \(with ESTOP and MCP/COM2 secondary RS-232 serial port\)](#)
- [RS-485 Multi-Drop Serial Port \(sometimes dedicated to PreciseFlex devices\)](#)
- [RS-485 Termination Jumper](#)
- [Spare Jumpers](#)
- [Status Output Signal](#)
- [System Reset Jumper](#)
- USB (not currently implemented)

The HVCPU and its connectors are shown below. To jump to the detailed information for a specific interface, click on the interface label or the connector/component in [Figure 4-4](#).

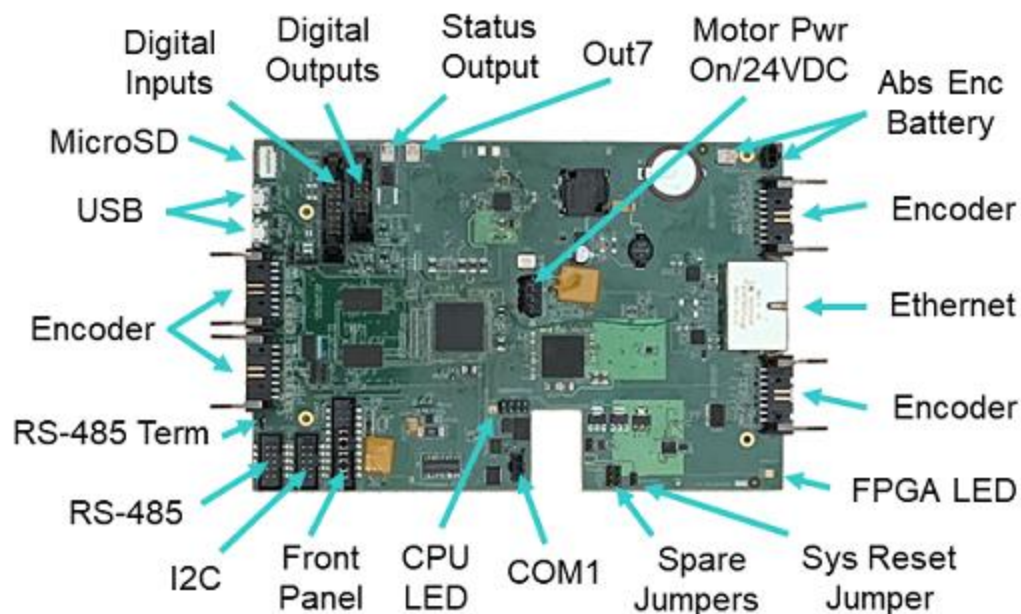

Figure 4-4: High Voltage CPU Board and Its Connectors

In the following sections, the pin-outs for each of the connectors plus the part numbers for the mating plugs are described. See the [Product Specifications](#) for detailed information on each of these interfaces for the various G6000 controller models.

HVCPU Board Jumpers and LEDs

The high voltage, high performance processor board (HVCPU) has a number of hardware jumpers that determine the configuration of some system hardware and software functions and some LEDs

that indicate the status of the board. Depending upon the type of jumper, there may be two or more jumper posts. Posts are tied (shorted) together using black jumper plugs. The two wide jumper posts for configuring the RS-485 daisy-chain termination are shown in [Figure 4-5](#).



Figure 4-5: Jumper Posts

The locations for each of the sets of jumpers and LEDs are illustrated in [Figure 4-6](#) and are identified by stenciled labels on the surface of the HVCPU board.

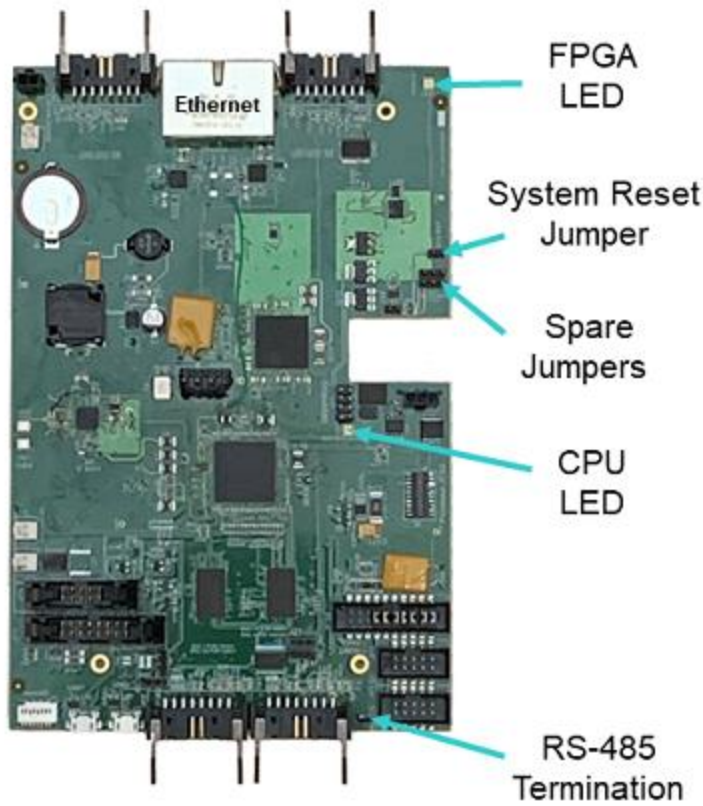

Figure 4-6: Locations for Jumpers and LEDs

[Table 4-1](#) describes each of these LEDs and sets of jumpers and how the pins must be shorted ("jumpered") in order to set a specific configuration. When a direction (e.g., left versus right) is described, it is with respect to the HVCPU board oriented as shown in [Figure 4-6](#).

Table 4-1: LEDs, Jumpers, and Shorted Pins

Jumpers	Description	Setting
J11/J10 Spare Jumpers	There are two sets of three posts whose use is currently undefined. For each set, when the center and right post is jumpered, the input is OFF. When the center and left post is jumpered, the input is ON. As shipped from the factory, these jumpers are set to OFF.	Not currently used.
J9 System Reset Jumper	If a jumper is installed on these two posts, when the system is restarted, the default configuration files (*.PAC) are applied instead of the standard files. This setting is utilized if a configuration file becomes corrupted or a setting inadvertently makes the system unusable. As shipped from the factory, this jumper is not installed.	Install jumper J9 to reset the system.
J2 RS-485 Termination	This jumper controls how the RS-485 serial communication lines are terminated. For reliable communications, if the controller is at the end of an RS-485 daisy chain, this jumper should be installed to terminate the line. If the controller is in the middle of an RS-485 daisy chain, this jumper must be uninstalled to disable the termination. As shipped from the factory, this jumper is installed and the RS-485 lines are terminated.	Install jumper J2 to terminate the RS-485 communication lines.
CPU/Status LED	This is a red and green LED that blinks different patterns to indicate the operational status of the controller. See the Status LED and Status Output Signal section of this manual for information on how to interpret the red/green blinking patterns.	
FPGA LED	This is a diagnostic LED that is connected to the FPGA chip. When the HVCPU is powered up and loading of the firmware into the FPGA is completed, this LED will blink green 4 times and then remain off.	

Abs Encoder Battery Connectors

Many commercially available absolute encoders require a modest amount of battery power in order to retain their counters when the PreciseFlex Controller is powered down. If a user's system is equipped with this type of encoder, a suitable battery source must be connected to one of the two encoder battery connectors. A two-pin Molex connector is provided for backwards compatibility. Alternately, an AMP two plug Mate-N-Lok connector provides a more secure means of connecting an external battery. From an electrical point of view, the two connectors are identical and have the same pin outs.

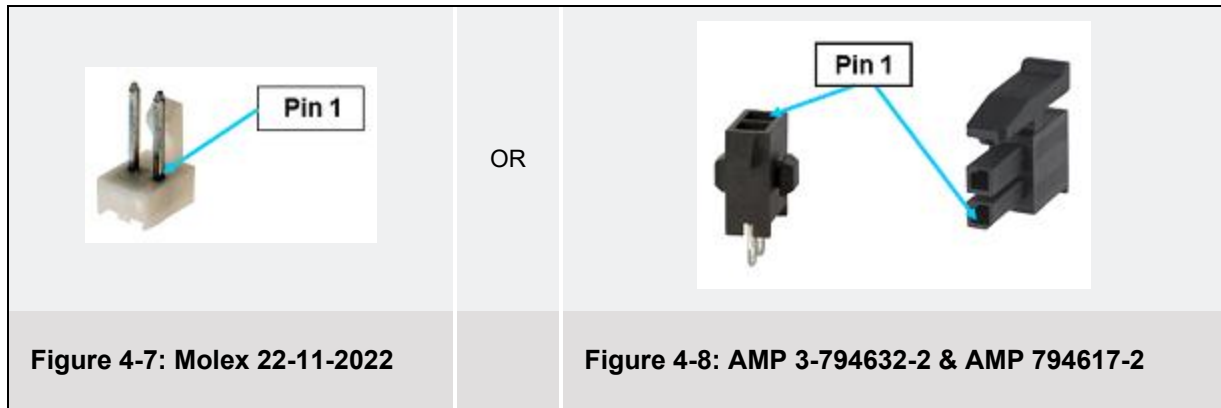

On the HVCPU board, the battery power flows from the input battery connectors to pins on the encoder connectors. See the reference pages for the [HVCPU Board Encoder Interfaces](#) for additional information. Also, refer to the specific information for the encoder for the recommended battery voltage and capacity.

NOTE: Due to the low voltage of batteries and the very low current drain of encoders in standby mode, a poor or higher resistance connection between the battery and the encoder can result in a momentary loss of power to the encoder. Even a very short loss of power can result in an absolute encoder losing its calibration data and signaling a low battery voltage error. Therefore, all connectors from the battery, through the controller and out to the encoder must be gold plated with high compression forces and all wires must have very low resistance.

Table 4-2: Pins & Plugs

Pin	Description
1	+VBAT
2	GND
User Plug Part for Molex 22-11-2022	Housing: TE 1375820-2, Sockets: TE 1375819-2
User Plug Part for AMP 3-794632-2	Housing: TE 794617-2, Sockets: TE 1-794610-2 (30AU) or TE 794606-2 (15AU)

COM1 Primary RS-232 Serial Interface

COM1 is the primary RS-232 serial communication port for the controller. Normally, this channel is configured to be a command interface that accepts Console requests and replies in human-readable text. In this mode, this port can be connected to an ASCII terminal emulation program such as HyperTerminal for direct operator interaction or may be connected to a host computer that issues commands and listens to replies. Alternatively, this serial port can be configured as a communications interface controlled by a GPL procedure; in this mode, it is referenced as device /dev/com1.

NOTE: Like COM2, the secondary serial interface, this primary serial interface does not support hardware flow control.

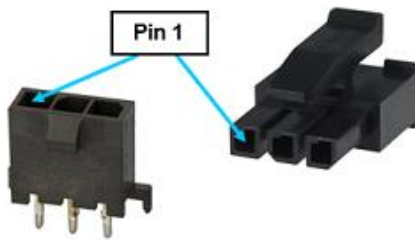

Figure 4-9: Connectors

Table 4-3: Pins & Plug

Pin	Description
1	RXD - controller receive data
2	Ground
3	TXD - controller transmit data
User Plug Part No	TE/AMP 1445022-3 3 mm 3POS MATE-N-LOK

Digital Inputs

The HVCPU provides twelve general-purpose optically isolated digital input signals that are accessed in a single IDC connector. This type of connector permits these signals to be easily interfaced to other devices.

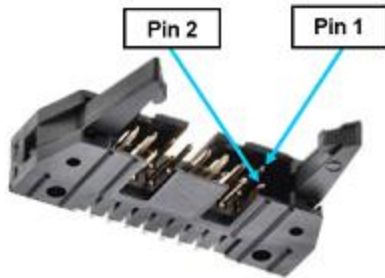

Figure 4-10: Connector

These inputs can be configured as either "sinking" or "sourcing" in groups of four (4) signals. If an input signal is configured as "sinking," the external equipment must provide a 5VDC to 24VDC voltage to indicate a logical high value or no voltage for a logical low. This configuration is compatible with "sourcing" (PNP) sensors.

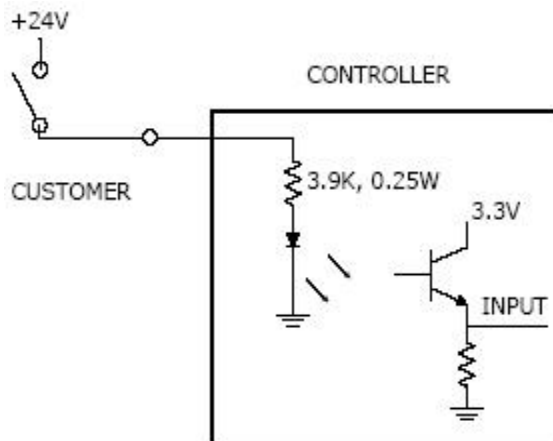

Figure 4-11: DIO Sinking Input

If an input signal is configured as "sourcing," the external equipment must pull the signal input pin to ground to indicate a logical high and must let the line float high to 24VDC to signal a logical low value. This configuration is compatible with "sinking" (NPN) sensors.

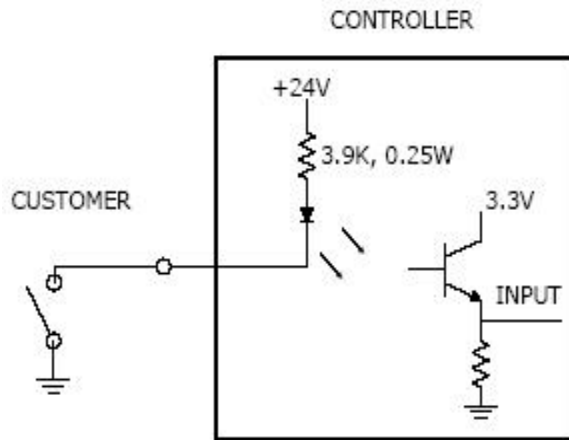

Figure 4-12: DIO Sourcing Input

In place of the hardware jumpers that were employed in earlier Guidance controllers to configure the sinking /sourcing mode of operation, in the G6000 controllers these settings are changed via software parameters. This method is more convenient especially if the controller is embedded in a robot. [Table 4-4](#) lists the parameter controls of the digital input's modes of operation.

Table 4-4: Software Parameters

Parameter Database ID	Parameter Name	Default Value	Description
531	DIN sink mode 1-4, 5-8, 9-12	0 (Sourcing)	For newer controllers that support software DIO configuration, this parameter sets and displays whether local digital input signals operate in sinking or sourcing mode. The input signals are set in groups of four. A group of inputs are sinking if their corresponding element is 1, otherwise a value of 0 indicates sourcing. By default, all local inputs (GPL signals 10001-10012) are set to sourcing.

To modify the sinking/sourcing mode of operation for a group of digital inputs, use a browser to open the controller's web interface and access the following page: **Setup** → **Parameter Database** → **Controller** → **System DIO**. To save modifications, click **Set new values** followed by **Save All to Flash**.

NOTE: Whenever saving to flash, to turn off the controller, wait 10 seconds after the "Flash Busy" indicator disappears to ensure the flash disk is not corrupted.

The pin out for the Digital Input Connector and the corresponding GPL signal numbers are described in [Table 4-5](#).

Table 4-5: Pin Out & GPL Signal Numbers

Pin	GPL Signal Number	Description
1		24VDC
2		GND
3	10001	Digital Input 1
4	10002	Digital Input 2
5	10003	Digital Input 3
6	10004	Digital Input 4
7	10005	Digital Input 5
8	10006	Digital Input 6
9	10007	Digital Input 7
10	10008	Digital Input 8
11	10009	Digital Input 9
12	10010	Digital Input 10
13	10011	Digital Input 11
14	10012	Digital Input 12
15		24VDC
16		GND
User Plug Part No		Amp 746285-3 or Molex 22-55-2161 or Molex 90142-0016. For the Molex plugs, use Molex pins 16-02-0103 and Molex crimp tool 63811-1000.

Digital Outputs

The HVCPU provides eight general-purpose digital output signals that are accessed in a single IDC connector. This type of connector permits these signals to be easily interfaced to other devices.

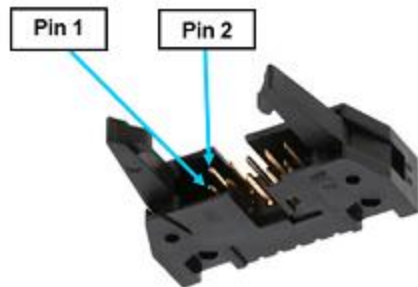

Figure 4-13: Connector

Each output can be individually configured as either "sinking" or "sourcing."

If an output signal is "sinking," the external equipment must provide a 5VDC to 24VDC pull-up voltage on the output pin and the controller pulls this pin to ground when the signal is asserted as true. This configuration is compatible with "sourcing" (PNP) devices.

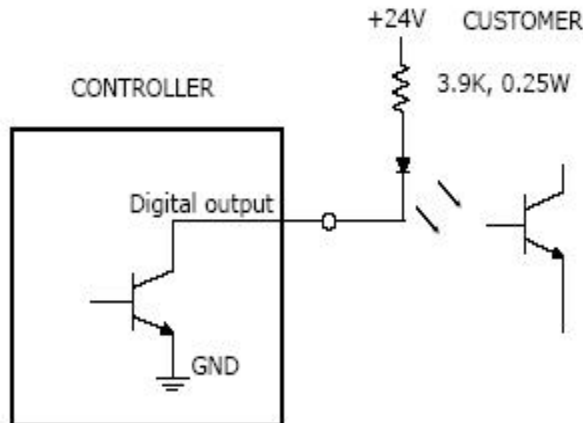

Figure 4-14: DIO Sinking Output

If an output signal is "sourcing," the external equipment must pull-down the output pin to ground and the controller pulls this pin to 24VDC when the signal is asserted as true. This configuration is compatible with "sinking" (NPN) devices.

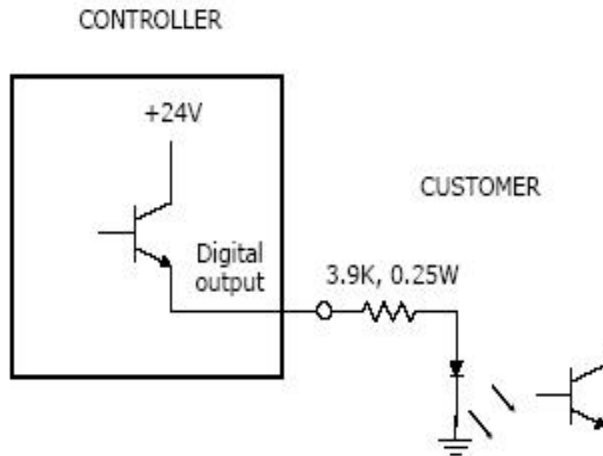

Figure 4-15: DIO Sourcing Output

In place of the hardware jumpers that were employed in earlier Guidance controllers to configure the sinking / sourcing mode of operation, in the G6000 controllers, these settings are changed via software parameters. This method is more convenient especially if the controller is embedded in a robot. [Table 4-6](#) lists the parameters that control the digital outputs modes of operation.

Table 4-6: Software Parameters

Parameter Database ID	Parameter Name	Default Value	Description
530	DOUT sink mode 1, 2, 3, 4, 5, 6, 7, 8	1 (Sinking)	For newer controllers that support software DIO configuration, this parameter sets and displays whether local digital output signals operate in sinking or sourcing mode. Each output signal's mode can be individually set. The output is sinking if its corresponding element is 1, otherwise a value of 0 indicates sourcing. By default, all local outputs (GPL signals 13-20) are set to sinking.

To modify the sinking/sourcing mode of operation for one or more digital outputs, use a browser to open the controller's web interface and access the following page: **Setup**→**Parameter Database**→**Controller**→**System DIO**. To save modifications, click **Set new values** followed by **Save All to Flash**.

NOTE: Whenever saving to flash, to turn off the controller, wait 10 seconds after the "Flash Busy" indicator disappears to ensure the flash disk is not corrupted.

The pin out for the Digital Output Connector and the corresponding GPL signal numbers are described in [Table 4-7](#).

Table 4-7: Pin Out & GPL Signal Numbers

Pin	GPL Signal Number	Description
1	13	Digital Output 1
2	14	Digital Output 2
3	15	Digital Output 3
4	16	Digital Output 4
5		24VDC
6		GND
7	17	Digital Output 5
8	18	Digital Output 6
9	19	Digital Output 7 - If it is desired to use this output separately from the other DOUT, as a wiring convenience, this signal is also available on the Output Signal 7 Connector .
10	20	Digital Output 8 - This digital output is often configured to track the controller's Status LED so that an external light can be driven to convey the same information. As a wiring convenience, this output signal is also available on the Status Output Signal Connector .
User Plug Part No		AMP 746285-1 or Molex 22-55-2101 or 90142-0010. For the Molex plug, use Molex pins 16-02-0103 and Molex crimp tool 63811-1000.

Ethernet Interface

In order to simplify networking equipment via Ethernet, PreciseFlex Controllers contain two 100 Mbit Ethernet RJ45 connectors. Either of these ports can be utilized with either a straight-thru or a cross-over Ethernet cable to connect to other equipment.



Figure 4-16: Connector and Cable

Both of the ports are interfaced to a built-in 100 Mbit Ethernet Switch that auto detects the sense of each cable. If the two ports are connected to equipment that are communicating with each other but

not the controller, the Ethernet switch automatically routes the traffic between the ports and does not send this information to the controller. For example, if an Ethernet camera is connected to one port and a PC is connected to the other port, the camera image data will not burden the controller's CPU.

See the *Setup and Operation Quick Start Guide* for instructions on setting the IP address for the controller.

I2C Interface

The HVCPU board provides an I2C interface that is dedicated to communicating with Brooks devices and is not available for connecting to customer equipment. This is a high-speed serial protocol that can be daisy-chained to interconnect multiple I2C devices. For example, I2C is utilized internally in the controller to interface to a series of temperature sensors and the NVRAM. For the 2000W PrecisePower Intelligent Motor Power Supply, an I2C connection provides power supply status information to the PreciseFlex Controller and is necessary to operate this power supply in a CAT-3 compliant mode. In the past, I2C was also used to interface to legacy Brooks gripper control boards.

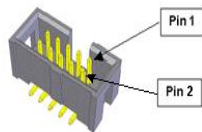

Figure 4-17: IDC Connector

Table 4-8: Pins & Plug

Pin	Description
1	24VDC
2	24VDC
3	GND
4	GND
5	GND
6	GND
7	SDA
8	VCC

Pin	Description
9	SCL
10	GND
User Plug Part No	Molex 22-55-2101. For this Molex plug, use Molex pins 16-02-0103 and Molex crimp tool 63811-1000.

Motor Power On/24VDC IN

This is a 4-pin header that is used to: (1) output signals that control turning on and off the external motor power supply and (2) input the 24VDC that powers the digital section of the controller. If a user purchases a PrecisePower Intelligent Motor Power Supply, Low Voltage Power Supply, and the Power Harness, there is a single cable that plugs into this header.

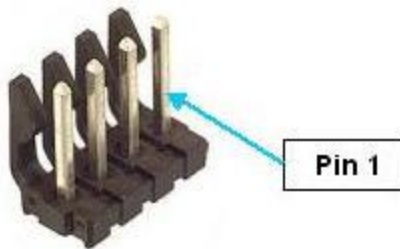

Figure 4-18: 24VDC Input Motor Enable

The motor "power on" signals are configured as a redundant pair of sinking signals. These should be wired to a pair of relays that are connected in series to enable and disable the motor power supply. Normally, 5 to 24VDC is applied to this control circuit. The external motor power supply should be turned on when the controller's logic switches the "power on" signals to ground. These signals are automatically opened when an E-Stop or other condition occurs that requires that the amplifiers be shut down.

The 24VDC power input and ground pins should be connected to a low voltage power supply that remains on independently of whether the motors are enabled. Turning off the 24VDC will completely shut down the controller.

The mating plug for this header is a Molex 09-50-3041 and the crimp style pins for this connector are 08-50-0105. The pin designations for this plug are listed in [Table 4-9](#).

Table 4-9: Pin Designations

Pin	Description
1	GND
2	+24VDC input
3	Motor power enable. Switched to ground when power is being enabled. Capable of sinking 2A at 24VDC.
4	Motor power enable (Redundant signal). Provided to comply with safety standards.
User Plug Part No	Molex 09-50-3041. For this Molex plug, use Molex pins 08-50-0105 and Molex crimp tool 63811-2200.

Output Signal 7 Connector

In addition to the [Status Output Connector](#) for Digital Output 8, if the controller is embedded, it is sometimes useful to employ a second digital output signal to drive an additional internal function. As a convenience, the 7th Digital Output (GPL signal 19) is duplicated in a two-pin header. This permits a device to be easily wired to this signal without having to breakout it out from the [Digital Outputs Connector](#).

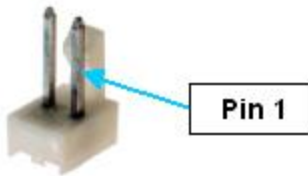

Figure 4-19: Two-Pin Connector

By default, the 7th Digital Output Signal is software configured as "sinking." If a "sourcing" signal is required, see the section on the [Digital Outputs Connector](#) for information on reconfiguring this output.

Table 4-10: Pins & Plug Descriptions

Pin	GPL Signal Number	Description
1	19	Digital Output 7
2		GND
User Plug Part No		Molex 22-01-2021 mates to Molex 22-23-2021 Header

Remote Front Panel Interface & COM2 (Secondary RS-232 Port)

The remote front panel interface provides the signals to implement a Category 3 (CAT-3) Safety front panel that includes a Manual Control Pendant. In particular, this connector provides signals (including redundancy as necessary) for implementing an E-Stop circuit, an auto/manual switch, a high power "on" button with a high power "on" indicator lamp, and a RS-232 interface to a Manual Control Pendant (COM2).

With the signals provided, customers can develop their own custom front panels (see the section on "Safety Circuits For Remote Front Panel" for a suggested design). Or, if a user's application does not require a Category 3 (CAT-3) front panel, the controller can be operated without a front panel or with only a simple E-Stop button or a Manual Control Pendant with an E-stop button.

When a front panel is not utilized, the following pins on the front panel connector must be jumpered in order for the controller to operate properly. (The controller is shipped with these jumpers installed.)

1-2, 3-4, 5-6, 7-8, 9-10, 11-12, 13-14

If a Manual Control Pendant is not connected to the secondary RS-232 port provided in this connector, the COM2 serial interface can be accessed for general communications purposes via a GPL procedure as device `/dev/com2`.

NOTE: Like COM1, the primary serial interface, this secondary serial interface does not support hardware flow control.

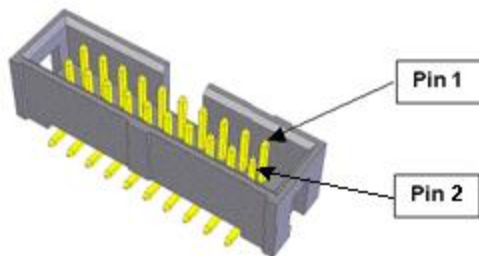

Figure 4-20: Connector

Table 4-11: Pins & Plug Descriptions

Pin	Description
1	Auto/Manual 2 (If no front panel or Auto/Manual switch, connect to pin 2). Input signal that is high to indicate that the system is being operated in a fully automatic mode or low or open for manual operation. This is normally controlled by a key switch on the Remote Front Panel of the master controller. During Manual Mode, only Jog mode motions are permitted and the servos restrict the axes to special "Manual mode max torque %" and "Manual mode speed limits" to ensure that the system can be safely manually operated. When this signal changes from Auto to Manual, motor power is automatically turned off and must be re-enabled to move the robot. The Auto/Manual signal is daisy chained to all controllers in the servo network.
2	24VDC
3	Auto/Manual 1 (If no front panel or Auto/Manual switch, connect to pin 4). Redundant Auto/Manual input signal.
4	24VDC
5	ESTOP_L 2 (If no front panel or E-Stop not asserted, connect to pin 6). An input signal that is low or open indicates that a hardware E-Stop condition has been asserted by some source. Set high if no E-Stop condition is asserted. The controller hardware will not permit motor power to be enabled when an E-Stop condition exists.
6	Force ESTOP_L. Output signal that, when low, indicates that the Remote Front Panel should force ESTOP_L 1 and ESTOP_L 2 to be asserted (low). The System Software toggles this signal low at startup to verify that the ESTOP_L 1, ESTOP_L 2, and External ESTOP circuits are properly working. The System Software also uses this as a means for asserting a hardware E-Stop condition during normal operation. This signal is normally held high.
7	ESTOP_L 1 (If no front panel or E-Stop not asserted, connect to pin 8). Redundant ESTOP input signal.
8	Force ESTOP_L. Redundant Force ESTOP_L output signal.
9	External ESTOP_L (If no front panel or not an External ESTOP, connect to pin 10). Diagnostic input signal that is low when an E-Stop is generated from an external source. This allows the System Software to display different error messages to alert the operator as to the source of the E-Stop condition.
10	Force ESTOP_L. Redundant Force ESTOP_L output signal.
11	High Power Lamp Fail (If no front panel, jumper to pin 12). Input signal that is set high or open if the Remote Front Panel lamp, which indicates when motor power is enabled, has failed. When this signal is high, motor power cannot be enabled.
12	Ground
13	High Power Enable (If no front panel, jumper to pin 14). Input signal that must transition from low to high during the EC Category 3 (CAT-3) power enable sequence to request that motor power be enabled. This is normally connected to a momentary contact "Enable power" push button on the Remote Front Panel.
14	Ground

Pin	Description
15	Spare
16	High Power Status. Output signal that is asserted (high) when high power to the motor is enabled. This is typically connected to a relay that turns on the High Power Lamp in the Remote Front Panel.
17	MCP / COM2 RXD. RS-232 receiver serial line from the Manual Control Pendant or external device.
18	MCP / COM2 TXD. RS-232 transmitter serial line to the Manual Control Pendant or external device.
19	5VDC. WARNING - This voltage is provided as a convenience but is limited in the current that can be supplied. Drawing excessive current can damage the controller. Consult Brooks if there is any question about the use of this voltage.
20	5VDC. WARNING - This voltage is provided as a convenience but is limited in the current that can be supplied. Drawing excessive current can damage the controller. Consult Brooks if there is any question about the use of this voltage.
User Plug Part No	Amp 746285-4 or Molex 22-55-2201 or Molex 90142-0020. For the Molex plugs, use Molex pins 16-02-0103 and Molex crimp tool 63811-1000.

RS-485 Serial Interface

RS-485 is a multi-drop serial communication interface. At the application level, it can transmit and receive data in a manner similar to an RS-232 interface with the added benefit that the communication lines can be daisy chained between multiple nodes instead of requiring point-to-point wiring. Within GPL application programs, this port is referenced as "/dev/com4."

For reliable communications, RS-485 lines must be terminated at both ends of the daisy chain and must not have any termination at interior nodes. The RS-485 termination is controlled by a [HVCPU Board Jumper](#). By default, this jumper is installed and the line is terminated, which means that the controller must be at one end of the RS-485 daisy chain until this jumper is removed.

The RS-485 interface is not available for interfacing to 3rd party devices when the controller is embedded in a Brooks robot such as a PreciseFlex or interfaced to a Guidance IO Module (GIO) or Guidance Slave Board (GSB). In these cases, the RS-485 supports a proprietary communication protocol that is used to interface to these Brooks devices.

This interface is provided in a 10-pin IDC connector.

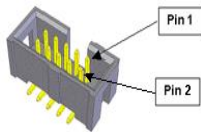

Figure 4-21: Ten-Pin IDC Connector

Table 4-12: Pins & Plug Descriptions

Pin	Description
1	24VDC. The PreciseFlex Controller can output a maximum of 2A at 24VDC on the RS-485 connector assuming that the controller's 24VDC power supply has sufficient power.
2	
3	GND
4	GND
5	GND
6	VCC
7	GND
8	RS485+
9	RS485-

Pin	Description
10	GND
User Plug Part No	AMP 746285-1 or Molex 22-55-2101 or 90142-0010. For the Molex plug, use Molex pins 16-02-0103 and Molex crimp tool 63811-1000.

Status Output Signal Connector

The HVCPU board includes a CPU LED that emits different blinking patterns to indicate the status of the controller. The execution conditions that are indicated by this LED are described in the [Status LED and Status Output Signal](#) section of this manual.

If the controller is embedded, an external LED can be connected to a Digital Output Signal and the blinking function can be mapped to this signal. As a convenience, the 8th Digital Output (GPL signal 20) is duplicated in a two-pin header. This permits an LED to be easily wired to the controller without having to breakout this signal from the [Digital Outputs Connector](#).

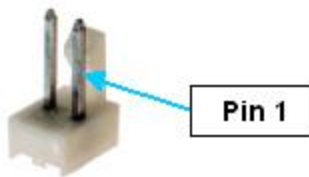

Figure 4-22: Two-Pin Connector

To configure the 8th Digital Output Signal to blink in synchronization with to the controller status, the "Power State DOUT" (DataID 235) value in the controller's Parameter Database should be set to "20." By default, the 8th Digital Output Signal is software configured as "sinking." In order to drive an LED, this signal must be configured as "sourcing." See the section on the [Digital Outputs Connector](#) for information on reconfiguring this signal.

Table 4-13: Pins & Plug Description

Pin	GPL Signal Number	Description
1	20	Digital Output 8
2		GND
User Plug Part No		Molex 22-01-2021 mates to Molex 22-23-2021 Header

HVCPU Board Encoder Interfaces

There are four 16-pin encoder connectors on the PreciseFlex G6000s top HVCPU board. Two of these connectors are mounted on each end of the HVCPU. Each of these connectors provides the signals necessary to interface to one or possibly two encoders. The numbering of these connectors defines how the software references these interfaces and the numbering is different in the 4-axis and the 6-axis versions of the controller.

For backwards compatibility with the previous generation of 4-axis Guidance G2400C controllers, the 4-axis version of the PreciseFlex G6000 has its encoders interfaces numbered as shown in [Figure 4-24](#).

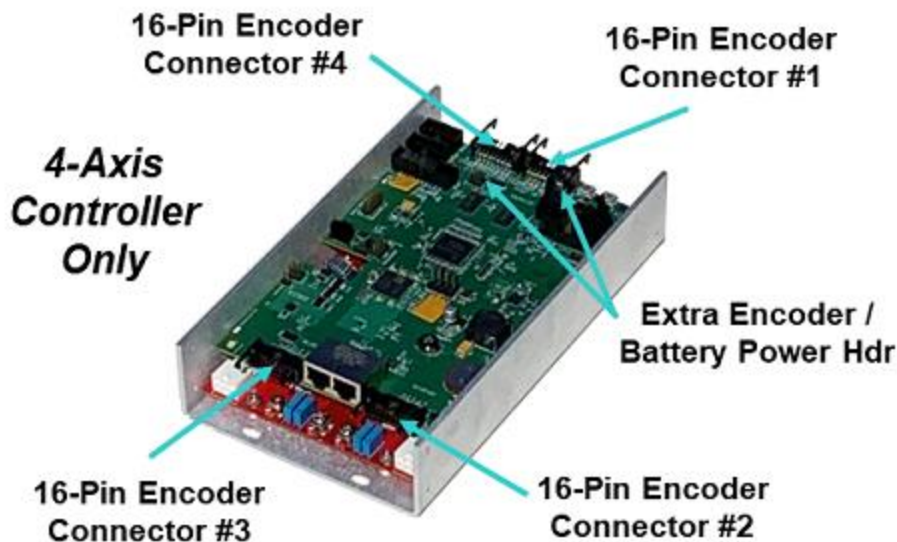

Figure 4-23: Encoder Connectors

In addition to the encoder interface signals, each encoder connector contains a pair of pins that are routed through the controller to an optional external encoder battery. This battery can provide backup power to absolute encoders when the controller is powered down. Each encoder connector also includes multiple ground pins and a single pin that provides 5VDC to power an encoder.

As a wiring convenience, when either or both of the two connectors at the far end of the controller are interfaced to two absolute encoders, the "Extra Encoder / Battery Power Headers" provide additional battery and 5VDC encoder power pins that eliminate the need to double crimp two wires to the standard pins in the encoder connectors. These headers reconfigure pins in the encoder connectors that are usually designated as extra grounds to provide additional external battery and 5VDC power instead. See below for more information on these headers.

In the 6-axis version of the PreciseFlex G6000 (as shown in [Figure 4-24](#)), the motor amplifiers and their connectors are re-arranged to permit optimal heat dissipation given the number of high voltage amplifiers that are provided in a very small footprint. Since the cables for motors and their

corresponding encoders are typically bundled together, the encoder channels are renumbered to simplify wiring to the controller.

The encoder connectors are configured so that a variety of incremental or absolute encoders can be connected to the controller. Pins 2, 3, 5, 6, 8, and 9 are allocated to the first encoder and are compatible with standard 5 VDC digital signals. Absolute encoders are interfaced via these same signal pins. (See "[Third Party Equipment Overview](#)" on page 87 for information on connecting supported absolute encoders.) Either single-ended or differential encoder signals can be connected to the primary encoder interface. (Absolute encoder interfaces may require a special "Enhanced Encoders" license due to special hardware and/or firmware requirements.)

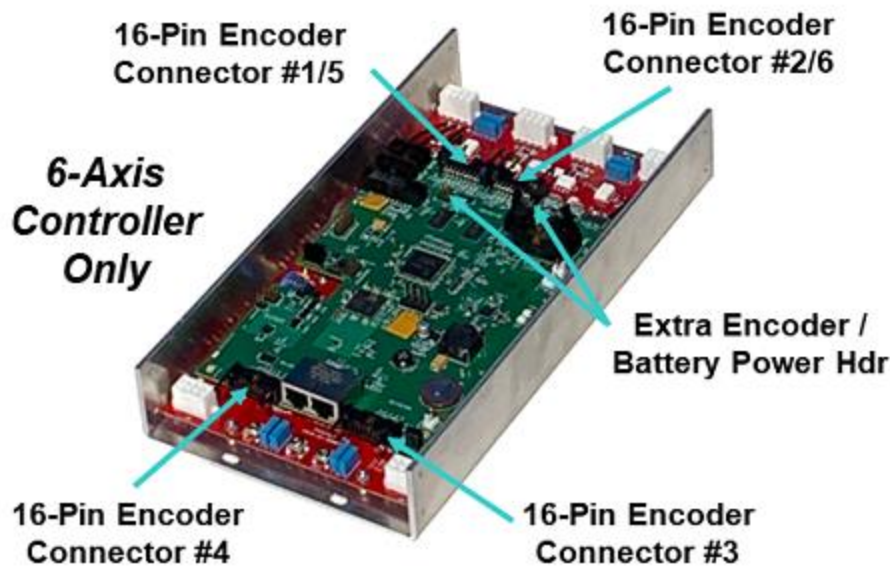

Figure 4-24: Encoder Connectors

In addition to the primary encoder interface, there are three digital inputs available in each encoder connector. These can be configured for hall-effect sensors or two over-travel sensors plus a homing sensor. When configured for these functions, they should be treated as standard 5VDC sourcing digital inputs connections. Alternatively, these three digital signals can interface to a second, single-ended encoder. This single-ended encoder can be used independently of the primary encoder or the two encoders can be used together to implement dual encoder loop servo control of an axis of motion.

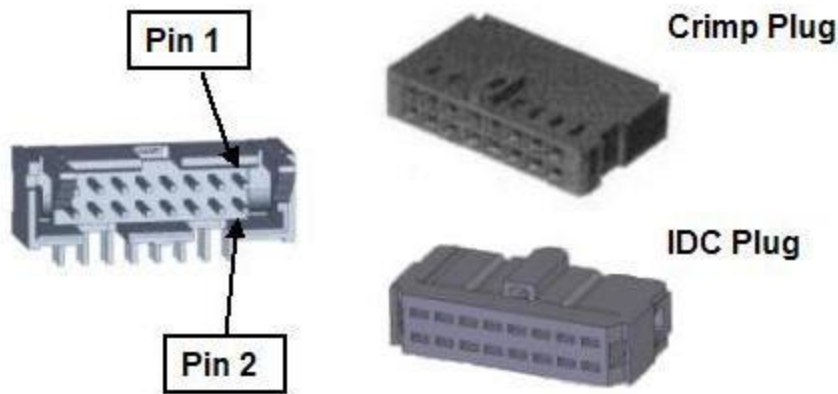

Figure 4-25: Encoder Plugs and Connectors

Table 4-14 defines the encoder connector pin outs. The second column should be used when the three digital inputs are configured for hall-effect sensors or over-travel switches and a homing sensor. The third column describes the pin outs when a second, single-ended encoder is utilized.

Table 4-14: Encoder Connector Pin Outs

Pin	3 Digital Inputs (5VDC)	2nd Encoder (5VDC)
1		Gnd
2		Encoder 1 A+
3		Encoder 1 A-
4	5VDC provided to power encoders. The sum of the current drawn from all four encoder connectors is limited to 1 amp.	
5		Encoder 1 B+
6		Encoder 1 B-
7		Gnd
8		Encoder 1 Z+

Pin	3 Digital Inputs (5VDC)	2nd Encoder (5VDC)
9	Encoder 1 Z-	
10	Gnd	
11	Digital Input #1 Hall #1 or Homing Switch	Encoder 2 A+
12	Normally Gnd (Reserved for Abs Encoder Battery Gnd). Alternately, for the JP7 and JP8 encoder connectors, this pin can provide Abs Encoder Battery Pwr if jumpers are changed on the "Extra Encoder / Battery Power Headers" J44 and J43 respectively.	
13	Digital Input #2 Hall #2 or Positive Over-Travel	Encoder 2 B+
14	Vcc (Reserved for Abs Encoder Battery Pwr)	
15	Digital Input #3 Hall #3 or Negative Over-Travel	Encoder 2 Z+
16	Normally Gnd. Alternately, for the JP7 and JP8 encoder connectors, this pin can provide 5VDC if jumpers are changed on the "Extra Encoder / Battery Power Headers" J22 and J21 respectively.	
Board Header	Amp 104315-03-3-o-s	
Crimp Plugs	Amp 102387-3 or Molex 90142-0016. For the Amp plug, use Amp pins 102128-1 and AMP crimp tool 91517-1. For the Molex plug, use Molex pins 16-02-0103 and Molex crimp tool 63811-1000.	
Alternate IDC Plug	Amp 746285-3	

As shipped from the factory, the JP7 and JP8 encoder connectors only provide one 5VDC power pin and one encoder battery power pin. If the controller is being interfaced to six absolute encoders, two encoders must be wired to each of these encoder connectors. To eliminate the need to double crimp to the encoder and battery power pins, the "Extra Encoder / Battery Power Headers" permit spare ground pins in JP7 and JP8 to be reconfigured to extra encoder and battery pins.

The "Extra Encoder / Battery Power Headers" consist of two groups of two three-post headers that are located close to the JP7/JP8 encoder connectors that they modify.



Figure 4-26: Jumper Posts

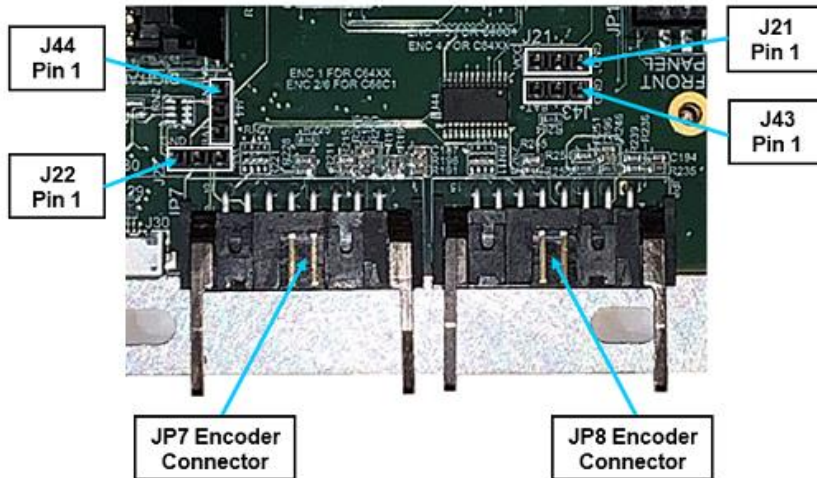

Figure 4-27: Encoder Connectors and Pins

The J43 header controls whether pin 12 of the JP8 encoder connector is connected to the encoder battery ground or the battery power source. The center post of the J43 header must be jumpered to either pin 1 or pin 3 as defined in [Table 4-15](#). Likewise, the J44 header controls whether pin 12 of the JP7 encoder connector is connected to the battery ground or the battery power source. By default, pins 1 and 2 of J43 and J44 will be shorted with a shunt. Move the shunt to pins 2 and 3 if using 6 absolute encoders in a 6-axis controller configuration (G6600).

Table 4-15: Pin Descriptions

Pin	Description
1	Abs Encoder Battery Gnd
2	JP7 or JP8 pin 12, jumper to pin 1 or 3
3	Abs Encoder Battery Pwr

The J21 header controls whether pin 16 of the JP8 encoder connector is a ground or a 5VDC source. The center post of the J21 header must be jumpered to either pin 1 or pin 3 as defined in

Table 4-16. Likewise, the J22 header controls whether pin 16 of the JP7 encoder connector is a ground or a 5VDC source. By default, pins 1 and 2 of J21 and J22 will be shorted with a shunt. Move the shunt to pins 2 and 3 if using six absolute encoders in a 6-axis controller configuration (G6600).

Table 4-16: Pins & Descriptions

Pin	Description
1	Ground
2	JP7 or JP8 pin 16, jumper to pin 1 or 3
3	5VDC encoder battery power

HVAMP Motor/Brake Interfaces

Each type of HVAMP board provides an identical, individual motor/brake connector to interface to each motor. The 4-axis High Voltage Amplifier (HVAMP4) has four motor amplifiers and four horizontally mounted 6-pin motor/brake connectors. The 6-axis High Voltage Amplifier (HVAMP6) has six motor amplifiers and six vertically mounted 8-pin motor/brake connectors. To maintain backwards compatibility with the legacy 4-axis Guidance G2400C while still providing optimal heat dissipation for the new 6-axis PreciseFlex G6600, the motor amplifier chips and motor connectors are arranged and numbered differently between the HVAMP4 and the HVAMP6.

Each of these motor amplifier boards and their numbered motor/brake connectors is shown below. For clarity in the illustrations, the amplifier boards are mounted in their sheet metal heatsinks, but the HVCPU boards (which are mounted above the HVAMPs) have been removed.

Figure 4-28 illustrates the positions and numbering of the motor connectors for the 4-axis PreciseFlex G6400 controller.

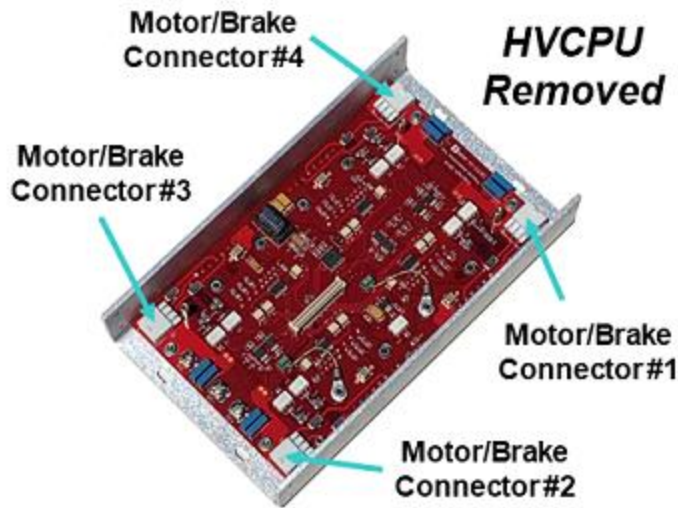



Figure 4-28: 4-Axis G6400 Controller

 DANGER Electrical Shock	
<p>The High Voltage Power Amplifiers (HV AMP4/6) and the Motor/Brake connectors and their leads contain unshielded high voltage pins, components and surfaces. It is intended that the PreciseFlex Controllers with these components be mounted in a cabinet or machine chassis that is not accessible when AC line power is turned on.</p>	

The mating plug and pins for the 6-pin motor/brake connectors of the G6400 are shown in [Figure 4-29](#). See the Amp Catalog 82181 page 91 for applicable wire gauges. Note that although each motor/brake connector has a brake signal, this is only provided as a wiring convenience. The PreciseFlex Controller turns all brake signals on and off at one time. Independent brake control for each motor is not supported via the dedicated IO lines available in this connector. If required, individual brake control can be implemented using general purpose digital output signals.

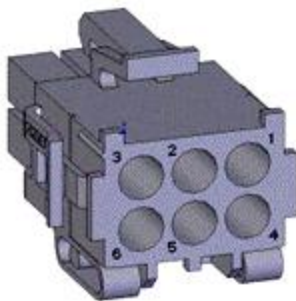



Figure 4-29: Mating Plug and Pins for the G6400's Six-Pin Motor/Brake Connectors

 **WARNING**

While many brakes draw less than 0.5A, for some large motors, the current draw can be much larger. If more than 2A is required for all brakes, an external relay should be used to separately power the brakes to avoid damaging the controller.



Table 4-17: Mating Plug & Pins for G6400 6-Pin Motor/Brake Connectors

Pin	Description
1	Brake Power 24VDC, maximum current 2A total for all brakes
2	Motor Phase V
3	Motor Phase W
4	Brake Power Return
5	Motor Frame Ground/Cable Shield
6	Motor Phase U
Board Connector Part No	AMP Mini Universal Mate-N-Lok 2 6 pin 770969-1
User Plug Part No	Amp 794190-1 (pins AMP 794231-1)
User Socket Part No	Amp 794231-1 for 16-20 gauge wire
Crimp Tool	Amp 91594-1

[Figure 4-30](#) illustrates the positions and numbering of the motor connectors for the 6-axis PreciseFlex G6600 controller.

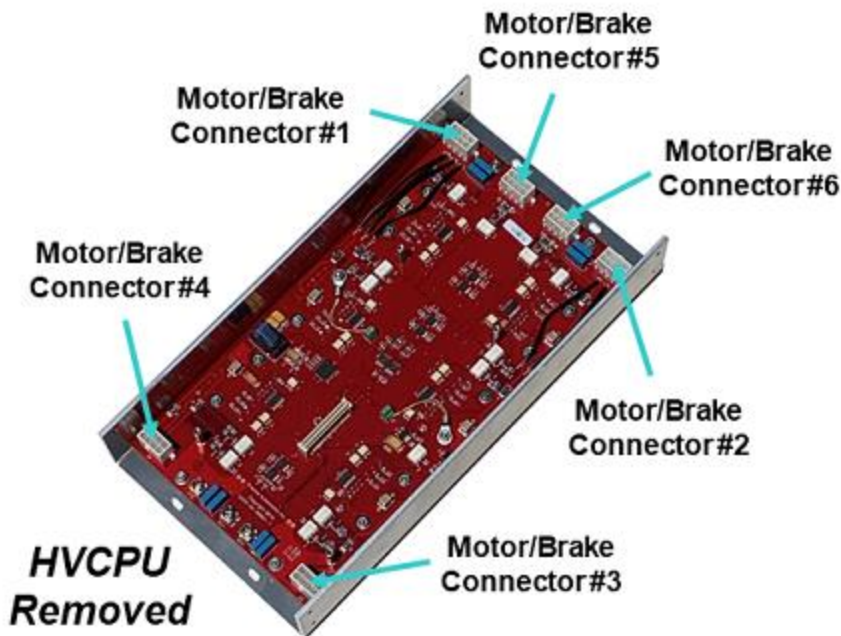

Figure 4-30: Motor Connectors Positions and Numbering for the Six-Axis G6600 Controller

The mating plug and pins for the 8-pin motor/brake connectors of the G6600 are shown below. See the Amp Catalog 82181 page 91 for applicable wire gauges. Note that although each motor/brake connector has a brake signal, this is only provided as a wiring convenience. The PreciseFlex Controller turns all brake signals on and off at one time. Therefore, independent brake control for each motor is not supported via the dedicated IO lines available in this connector. If required, individual brake control can be implemented using general purpose digital output signals.

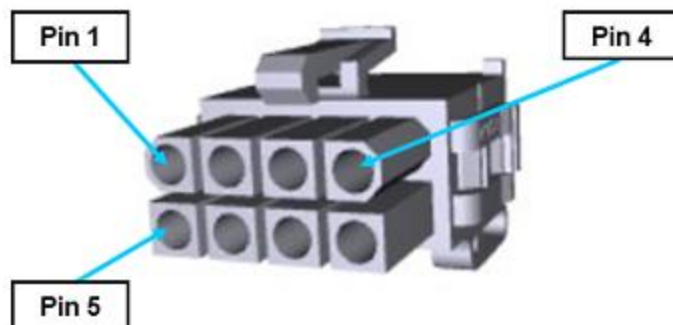



Figure 4-31: Mating Plug & Pins for G6600 Eight-Pin Motor/Brake Connectors

 **WARNING**

While many brakes draw less than 0.5A, for some large motors, the current draw can be much larger. If more than 2A is required for all brakes, an external relay should be used to separately power the brakes to avoid damaging the controller.



Table 4-18: Descriptions, Mating Plug & Pins for G6600 Eight-Pin Motor/Brake Connectors

Pin	Description
1	Motor Phase U
2	Motor Frame Ground/Cable Shield
3	No connection
4	Brake Power Return
5	Motor Phase W
6	Motor Phase V
7	No connection
8	Brake Power 24VDC, maximum current 2A total for all brakes
Board Connector Part No	AMP Mini Universal Mate-N-Lok 2 8 pin 794065-0
User Plug Part No	Amp 794192-1 (pins AMP 794231-1)
User Socket Part No	Amp 794231-1 for 16-20 gauge wire
Crimp Tool	Amp 91594-1

Low-Voltage Power Supply

The PreciseFlex Controller requires a minimum of 2.7 Amps and preferably 4 Amps of 24VDC power for the logic and IO. An additional 1 Amp is required to operate the dual safety contactors on the 2000W PrecisePower Intelligent Motor Power Supply.

A commercially available 24VDC power supply, the Mean Well P/N EPS-120-24 is shown in [Table 4-19](#). This is a frameless supply that should be mounted on 4 mm high standoffs. Mounting holes are located on 44.45 mm by 95.25 mm centers. The AC input connector is a JST VHR-3N and the DC output connector is a JST VHR-4N. For the AC input connector, Pins 1 & 3 provide the power. For the DC output connector, Pins 3 & 4 are GROUND and pins 1 & 2 are 24VDC.

For the JST VHR connectors, use pins SVH-21T-1.1 and JST crimp tool WC-160.

DANGER
Electrical Shock Hazard

The Mean Well 24VDC power supply is an open frame electrical device that contains unshielded high voltage pins, components and surfaces. This product is intended to be mounted in a cabinet or machine chassis that is not accessible when AC line power is turned on



Table 4-19: Power Supply Specifications

General Specification	Range
Input voltage	80 - 264 VAC
Input frequency	47 - 63Hz
Output voltage	24VDC
Output power	120 Watts
Operating temperature	-30 - +70 deg C
Storage temperature	-40 - +85 deg C
Dimensions	101.6 x 50.8 x 29 mm

Motor Voltage Power Supplies

The PreciseFlex G6000 Controllers can operate with motor bus voltages ranging from 24VDC to 340VDC. Users may employ their own DC motor power supply or may purchase an intelligent motor power supply from Brooks .

Brooks offers three Intelligent Motor Power Supplies:

- PrecisePower 300 (300 or 600 Watts RMS)
- PrecisePower 1000 (1000 Watts RMS)
- PrecisePower 2000 (2000 Watts to 3400 Watts RMS).

These units include:

- Integral relays for enabling/disabling motor power on command from the controller
- Large value output filter capacitors to store deceleration energy for use when power is needed
- The ability to absorb line spikes, and built-in fuses

To permit the PreciseFlex Controller to enable and disable motor power, the power supply must be equipped with either one or two (redundant) relays. These relays should be wired to the "Motor power enable" signals provided on the [Motor Power On/24VDC](#) header on the controller.

If a user buys a PrecisePower unit and a standard low voltage power supply, the user can also get a PreciseFlex Controller Power Harness that interconnects the two power supplies and the PreciseFlex Controller (see the section on [Power Connectors and Grounding](#)).

Regarding the sizing of the motor power supply, as a rule-of-thumb for a typical industrial robot, a motor power supply can drive a group of motors whose total rating is approximately four times the rating of the motor power supply. For example, the 300/600 Watt PrecisePower 300 can normally drive motors with a total rating of up to 2400 Watts. This is due to the fact that motor power ratings are typically defined by the "rated torque" that can be supplied at the "rated speed" of the motor. However, in most robot applications, high torque is only required at low speed. As a case in point, the PrecisePower 300 has been successfully used to drive a Cartesian robot at full speed where the size of its four motors are 750 W, 400 W, 200 W and 100 W (1450 W total).



PrecisePower 300 Intelligent Motor Power Supply

The PrecisePower 300 is an Intelligent Motor Power Supply with an input range from 90 to 264 VAC 50/60 Hz. The motor power output voltage is a multiple of the input line voltage (output = $1.41 \times \text{RMS_VAC_input} - 2$ Volts). With 120 VAC input, this power supply generates approximately 167VDC and 300 watts RMS. With 240 VAC input, the output is approximately 337VDC and 600 watts RMS. This unit includes a single integral relay for enabling and disabling motor power from the controller, large value output filter capacitors to store deceleration energy for use when power is needed, the ability to absorb line spikes, and built-in fuses.

To enable the power supply's relay, a three conductor cable must connect the controller's [Motor Power On/24 VDC](#) connector to the three pin header pictured below in the bottom right of the power supply. This cable should connect the controller's "Motor power enable" signal, 24VDC and ground to the corresponding pins on the motor power supply. The 24VDC and ground signals must in turn be connected to the 24VDC power supply, which provides low voltage power to both the controller and the motor power supply. To connect to the three-pin header to the motor power supply, a Molex 09-50-3031 or compatible plug can be utilized.

This motor power supply includes push on tabs for the input AC power and the output DC power. The DC output is provided as a pair of output terminals that must be connected to the DC motor power input screw terminals on the High Voltage Amplifier Board (HVAMP) of the PreciseFlex G6000 Controller (see the section on [Power Connectors and Grounding](#)). Both the DC output terminals of the power supply and the AC input terminals use tabs compatible with Amp 3-520133-2 Faston receptacles.

This power supply limits inrush current to 6 Amps. It is protected against voltage surge to 2000 Volts common mode by means of MOVs at the line input. It is protected against over current by two 6.3 amp, 250V quick acting fuses, Wickman (PN 1941630000).

 DANGER Electrical Shock	
<p>The PrecisePower 300 Intelligent Motor Power Supply is an open frame electrical device that contains unshielded high voltage pins, components and surfaces. This product is intended to be mounted in a cabinet or machine chassis that is not accessible when AC line power is turned on.</p>	

For mounting purposes, the power supply has four 4.1 mm through holes as illustrated in [Figure 4-32](#).

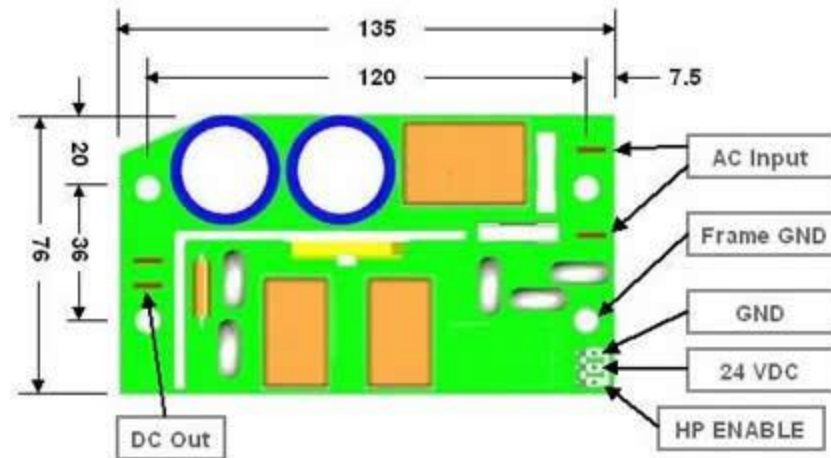

Figure 4-32: Power Supply with Four 4.1 mm Through Holes for Mounting

PrecisePower 1000 Intelligent Motor Power Supply

For applications requiring a larger intelligent motor power supply, the PrecisePower 1000 delivers 1000 Watts of power from a single-phase 208 VAC service. This unit includes an integrated relay for enabling and disabling motor power on command from the controller, large value output filter capacitors to store deceleration energy for use when power is needed, the ability to absorb line spikes, the ability to limit the peak output voltage, and built-in fuses.

To enable the power supply's relay, a three conductor cable must connect the controller's [Motor Power On/24VDC](#) connector to the three-pin header pictured below in the bottom right of the power supply. This cable should connect the controller's "Motor power enable" signal, 24VDC and ground to the corresponding pins on the motor power supply. The 24VDC and ground signals must in turn be connected to the 24VDC power supply, which provides low voltage power to both the controller and the motor power supply. To connect to the three pin header to the motor power supply, a Molex 09-50-3031 or compatible plug can be utilized.

This intelligent motor power supply includes push on tabs for the input AC power and the output DC power. The DC output is provided as a pair of output terminals that must be connected to the DC motor power input screw terminals on the High Voltage Amplifier Board (HVAMP) of the PreciseFlex G6000 Controller (see the section on [Power Connectors and Grounding](#)). Both the DC output terminals of the power supply and the AC input terminals use tabs compatible with Amp 3-520133-2 Faston receptacles.

For mounting purposes, the power supply has four 4.5 mm through holes as illustrated in the drawing below.

This power supply can accept line voltages from 90 VAC to 240 VAC. The motor power output voltage is a multiple of the input line voltage ($\text{output} = 1.41 \times \text{RMS_VAC_phase_to_phase_input} - 2$ volts). For example, a 120 VAC input will produce 167 VDC output, whereas a 240 VAC input will

generate a 337VDC output. The maximum RMS power output of the unit is 1000 Watts at 240 VAC single phase. This single-phase AC voltage is available worldwide.

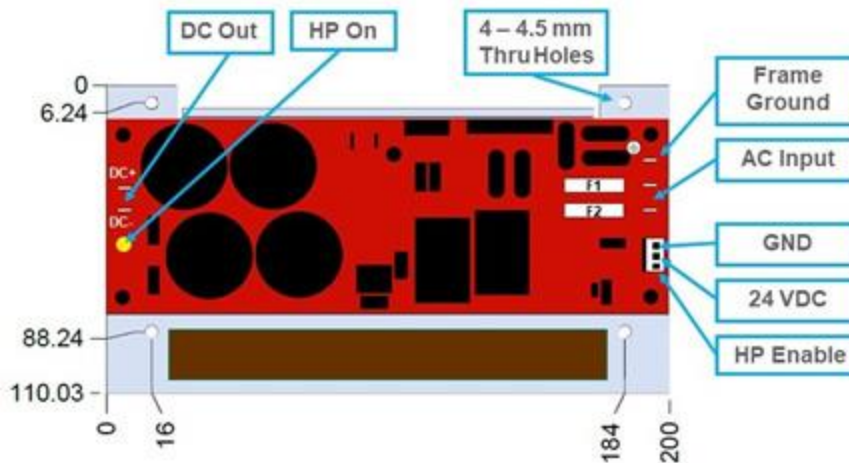



Figure 4-33: Power Supply with Four 4.5 mm Through Holes for Mounting

 DANGER Electrical Shock	
<p>The PrecisePower 1000 Intelligent Motor Power Supply is an open frame electrical device that contains unshielded high voltage pins, components and surfaces. This product is intended to be mounted in a cabinet or machine chassis that is not accessible when AC line power is turned on.</p>	

PrecisePower 2000 Intelligent Motor Power Supply

For applications requiring an even larger intelligent motor power supply, the PrecisePower 2000 delivers 2000 Watts of power from a single-phase 208 VAC service or 3400 Watts from a three-phase 240 VAC service. This unit includes dual integrated relays for enabling and disabling motor power on command from the controller, large value output filter capacitors to store deceleration energy for use when power is needed, the ability to absorb line spikes, the ability to limit the peak output voltage, and built-in fuses. In addition, it has safety circuits to automatically shut down the unit if it is switched to a short or is severely over-loaded.

In order to power the logic in this unit, 24 VDC must be provided from a separate 24 VDC power supply. As a wiring convenience, the AC line voltage input to the PrecisePower 2000 is presented on two pins that can be utilized to power the 24 VDC supply. For these pins as well as two other headers, mating cables can be connected to the PrecisePower via a Molex 09-50-3031 or compatible plug.

To enable the PrecisePower's motor power output, its redundant dual relays must be connected to the [Motor Power On/24 VDC](#) header of the controller and be enabled by the controller. A four



conductor cable should be used to connect the two "Motor power enable" signals, 24 VDC and ground. The 24 VDC pin on the controller header is the DC input that provides power for the controller's logic. PrecisePower routes its 24 VDC input to the controller via this cable to simplify system wiring. If the PrecisePower is automatically shut down by a fault condition detected by its safety circuits, this motor power supply can be reset by cycling the 24 VDC power.

To satisfy IEC Category 3 (CAT-3) requirements and to report power supply errors to the controller, a 10-pin 26AWG ribbon cable should be routed from the PrecisePower unit to the [I2C interface](#) on the PreciseFlex Controller.

This intelligent motor power supply includes push on tabs for the input AC power and the output DC power. The DC output is provided on two duplicate pairs of output terminals. One of these pairs must be connected to the DC motor power input screw terminals on the High Voltage Amplifier Board (HVAMP) of the PreciseFlex G6000 Controller (see the section on [Power Connectors and Grounding](#)). Both the DC output terminals of the power supply and the AC input terminals use tabs compatible with Amp 3-520133-2 Faston receptacles.

This power supply can accept line voltages from 90 VAC to 240 VAC. The motor power output voltage is a multiple of the input line voltage (output = $1.41 \times \text{RMS_VAC_phase_to_phase_input} - 2$ volts). For example, a 120 VAC input will produce 167 VDC output, whereas a 240 VAC input will generate a 337 VDC output. The maximum RMS power output of the unit is 2000 Watts at 240 VAC single phase or 3400 Watts at 240 VAC 3-phase. The single phase AC voltage is available worldwide.

To connect this power supply to a 3-phase AC source, simply connect the 3rd phase to the L3 Faston tab. The 3-phase voltage compatible with this unit is only available in certain countries, notably the U.S., Japan, and other parts of Asia.

 WARNING	
<p>For this unit, the voltage from PHASE-TO-PHASE must not exceed 240 VAC. Some countries specify their power in terms of the voltage of each phase relative to ground.</p> <p>NOTE: A three-phase power source specified at 220 VAC will damage the power supply if the phase-to-phase voltage exceeds 240 VAC.</p>	

In order for the controller to test if the power supply is correctly receiving single phase or 3 phase AC input, a jumper labeled J4 (3PH) is provided on the power supplies vertical control board. If this jumper is installed and 3 phase AC is not detected, a warning message will be displayed by the controller when motor power is enabled. If the power supply is only connected to single phase AC, this jumper should be removed to suppress the warning message.

For 2000 Watts and above, forced air is required to cool the PrecisePower 2000. A 24 VDC output connector is provided to power an optional fan.



DANGER

Electrical Shock

The PrecisePower 2000 Intelligent Motor Power Supply is an open frame electrical device that contains unshielded high voltage pins, components and surfaces. This product is intended to be mounted in a cabinet or machine chassis that is not accessible when AC line voltage is turned on.



For mounting purposes, the power supply has four 4.2 mm through holes as illustrated in [Figure 4-34](#).

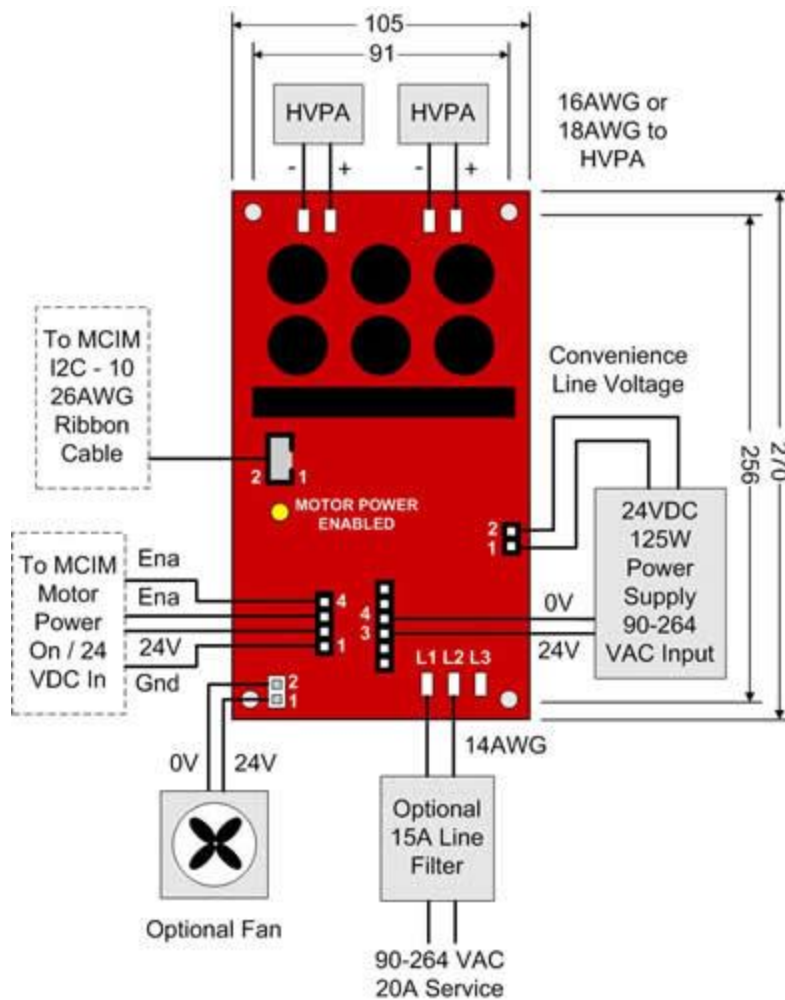

Figure 4-34: Power Supply with Four 4.2 mm Through Holes for Mounting

Safety Circuits For Remote Front Panel

Figure 4-35 presents an example of a Category 3 (CAT-3) user front panel and manual control pendant that can be interfaced to the [Remote Front Panel Connector](#) provided on the High Voltage CPU board (HVCPU). For the signals that route to the Remote Front Panel Connector, the pin numbers are denoted in parentheses.

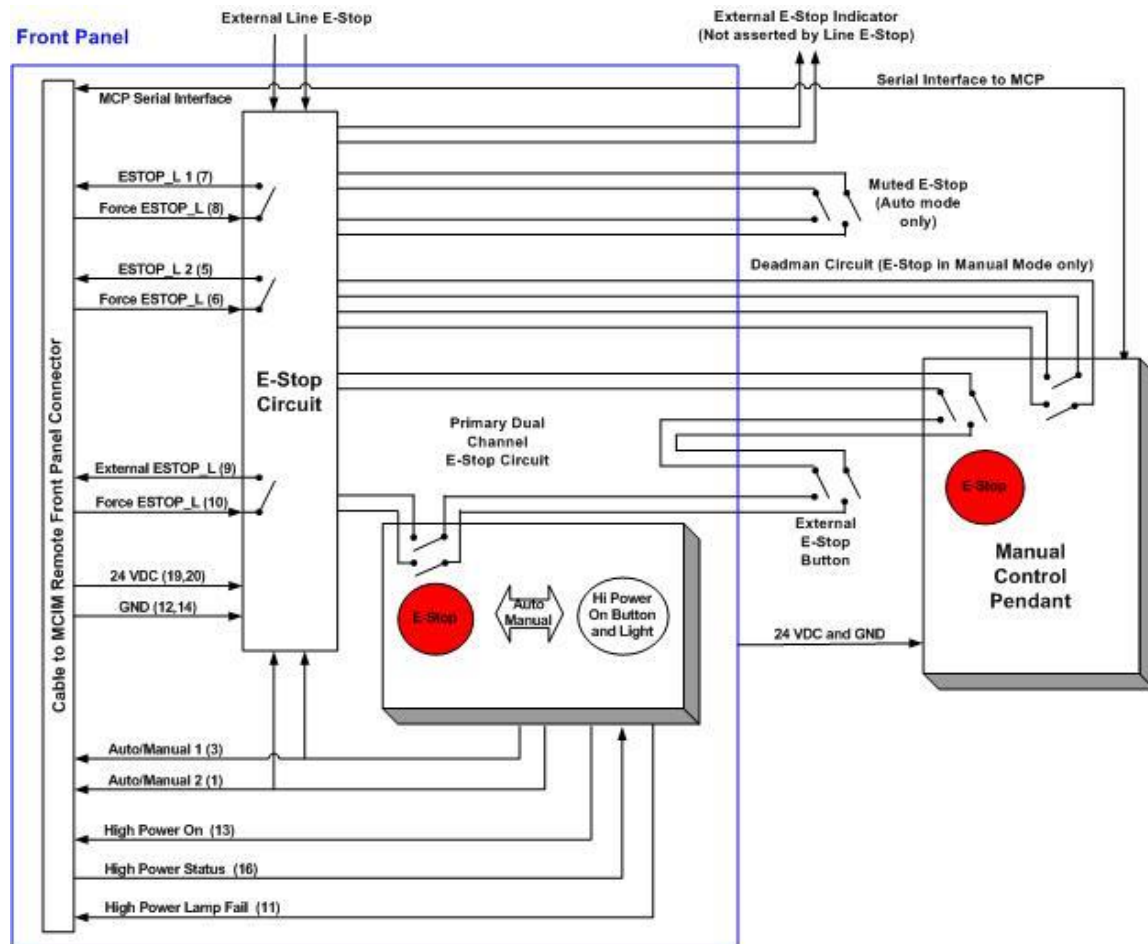

Figure 4-35: Remote Front Panel

If an application not require this level of operator interaction or compliance with Category 3 (CAT-3) safety regulations, the [Remote Front Panel Connector](#) documentation provides directions on how to jumper this connector for proper operation of the controller without a front panel.

Some of the features of the example Remote Front Panel Safety Circuit are briefly described in the following paragraphs.

The example Remote Front Panel circuit supports several different sources of E-Stop signals. Some of these E-Stops are always active while others are only active in certain modes of operation. Whenever an active E-Stop is asserted, the ESTOP_L 1 and ESTOP_L 2 signals are asserted by disconnecting them from the Force ESTOP_L signals. The possible E-Stop sources include the following:

External E-Stop Button: Normally connected to an E-Stop button or series of E-Stop buttons that are placed around the work cell.

External Line E-Stop: Typically utilized by external equipment in the cell or the manufacturing line to E-Stop the controller as well as other devices. In order to avoid a dead-lock condition, the External E-Stop Indicator Signal is asserted when any E-Stop source other than the External Line E-Stop is asserted. The External E-Stop Indicator should not be asserted by the External Line E-Stop signal to avoid a dead lock condition that could occur if an external device (such as a line control PLC) were to loop back the External E-Stop Indicator to the External Line E-Stop signal.

Muted E-Stop: This signal only generates an E-Stop Condition in Auto Mode. This allows the Muted E-Stop to be connected to a safety gate that surrounds the equipment. Opening the safety gate during normal automatic operation will turn off high power. However, during Manual Mode, an operator can open the gate and enter the cell without disabling high power.

MCP Deadman's Circuit: This circuit must be closed in order to operate the system during Manual Mode. A Deadman's circuit is typically connected to a 3 position hold-to-run switch integrated into the MCP. The Deadman's circuit is ignored during Auto Mode.

The Auto/Manual signals are connected to a key switch that sets whether the system is being operated in automatic mode or manual mode. The setting of this switch also affects the Muted E-Stop and the MCP Deadman's Circuit.

The High Power Status signal that is output from the communication interface connector is routed to a relay that turns on a lamp that indicates if motor power is enabled. Normally, this signal blinks at a rate of 1Hz when motor power is enabled. If this lamp fails, the High Power Lamp Fail signal is asserted and motor power cannot be enabled until this problem is corrected.

The **High Power On** button is a momentary contact switch that transitions the **High Power On** signal from low to high during the Category 3 (CAT-3) power enable sequence.

For the example front panel and signal diagram that is shown above, the following table summarizes how the various signals should interact to generate the controller's Remote Front Panel Interface input signals.

Table 4-20: Signal Interaction Summary

Controller's Remote Front Panel Input Signals	Input State Determined As Follows
ESTOP_L 1 and 2	Asserted if the following signals or statements are true: [Primary Dual Channel E-Stop] OR [External Line E-Stop] OR [Muted E-Stop AND (Auto/Manual set to Auto)] OR [Dead Man Circuit AND (Auto/Manual set to Manual)] OR [Force E-Stop].
External ESTOP_L	Asserted if the following signals are true: [External Line E-Stop] OR [Force E-Stop].
Auto / Manual 1 and 2	Asserted if the Auto / Manual key switch is set to Auto, off when the key switch is set to Manual.
High Power On	Momentarily asserted when the High Power On button is pressed.
High Power Lamp Fail	Asserted if the High Power On status light fails.

5. Third-Party Equipment

Third Party Equipment Overview

This section contains instructions on interfacing to 3rd party equipment that is commonly utilized in combination with the PreciseFlex Controllers. For detailed information on each of these products, refer to the manuals provided by the manufacturers of these components.

Panasonic A4/A5/A6 Serial Incremental/Absolute Encoders

This section provides wiring instructions for a Panasonic or Bosch motor equipped with a Panasonic high resolution serial encoder. These encoders transmit their position data as a serial bit stream via RS-485 lines rather than A-B incremental pulses. The supported absolute encoder models include the A4 17/33-bit, 17/32-bit bus line and the A6 23/39-bit encoders. These models require a battery backup in order to supply continuous power to the encoder to maintain their 16 or 15 bit "turns count" registers. These encoders can also be used as serial incremental encoders that require no external battery backup. Additionally, the A4 10000 count and the A5 20-bit serial incremental encoders are supported, which require no battery backup.

Due to the additional capabilities needed to process the absolute encoder signal, these encoders may require the "Enhanced Encoders" license. Contact Brooks for the current hardware requirements for interfacing to these types of encoders.

For information on configuring this type of encoder, see the *Software Setup* section of the *Controller Software* section of the *PreciseFlex Library*.

In addition to [Table 5-1](#), review the [Installation Information](#) for important recommendations on the use of twisted pair wires and shield grounding.

Table 5-1: Encoder Connections

Encoder Connector Pin	Wire Color	Signal Name	G6000 Connector Pin
1	RED	BATTERY+	14

Encoder Connector Pin	Wire Color	Signal Name	G6000 Connector Pin
2	PINK	BATTERY -	12
3	GREEN	FG	7
4	BLUE	PS+	2
5	VIOLET	PS-	3
6	NC	NC	
7	WHITE	VCC	4
8	BLACK	GND	1
9	NC	NC	

When six absolute encoders are utilized with a 6-Axis PreciseFlex G6600 controller, the 1st and 2nd Encoder Connectors support additional signals to interface to absolute encoders for motors 5 and 6, respectively. In this situation, additional 5VDC encoder power and encoder battery power pins can be obtained by using the ["Extra Encoder / Battery Power Headers."](#)

Table 5-2: Encoder & Connector Pins

2nd Encoder Connector Pin	Wire Color	Signal Name	G6600 Connector Pin
3	GREEN	FG	16
4	BLUE	PS+	5
5	VIOLET	PS-	6

Table 5-3: Wiring Instructions for Motor Power Connectors

Motor Connector Pin	Wire Color	Signal Name	G6000 Connector Pins	
			G6400	G6600
1	RED	U	6	1
2	WHITE	V	2	6
3	BLACK	W	3	5
4	GREEN	GND	5	2

Motor Connector Pin	Wire Color	Signal Name	G6000 Connector Pins	
			G6400	G6600
1	YELLOW	BRAKE+	1	8
2	YELLOW	BRAKE-	4	4

If the encoder requires battery backup, a battery must be connected to the [Absolute Encoder Battery Connector](#) on the HVCPU board. See the information on that connector for detailed pin outs and plug types. [Table 5-4](#) contains information on the required battery power.

Table 5-4: Required Battery Power

External Battery Specification	
Maximum voltage	4.75V
Typical voltage	3.6V
Alarm trigger voltage	3.1V
Current for each encoder	3.6 uA

Tamagawa Serial Incremental/Absolute Encoder

This section provides wiring instructions for a motor equipped with a Tamagawa SA35-17/33Bit-LPS (TS5667N120/N127) absolute encoder or a Tamagawa 23/39-bit serial absolute encoder. These encoders transmit their position data as a serial bit stream via RS-485 lines rather than A-B incremental pulses. For these absolute encoders to provide high resolution 33-bit or 39-bit absolute encoder position information, they must be provided with continuous power with a battery backup. The continuous power maintains a 16-bit "turns count" register that augments the single turn data. Alternately, the first encoder can be configured as a high resolution 17-bit serial incremental encoder that utilizes only the single turn data and does not require a battery backup.

Due to the additional capabilities needed to process the absolute encoder signal, these encoders may require the "Enhanced Encoders" license. Contact Brooks for the current hardware requirements for interfacing to these types of encoders.

For information on configuring this type of encoder, see the *Software Setup* section of the *Controller Software* section of the *PreciseFlex Library*.

In addition to [Table 5-5](#), review the [Installation Information](#) for important recommendations on the use of twisted pair wires and shield grounding.

Table 5-5: Encoder Connections

Tamagawa Motor Pin	Wire Color	Signal Name	G6000 Connector Pin
A4	BROWN	BATTERY+	14
B4	BROWN/BLACK	BATTERY -	12
B6	GRAY	FG	7
A3	BLUE	PS+	2
B3	BLUE/BLACK	PS-	3
A5	RED	VCC	4
B5	BLACK	GND	1

When six absolute encoders are utilized with a 6-Axis PreciseFlex G6600 controller, the 1st and 2nd Encoder Connectors support additional signals to interface to absolute encoders for motors 5 and 6, respectively. In this situation, additional 5VDC encoder power and encoder battery power pins can be obtained by using the "[Extra Encoder / Battery Power Headers.](#)"

Table 5-6: Pins & Encoder Wires

Tamagawa Motor Pin	2nd Encoder Wire Color	Signal Name	G6000 Connector Pin
B6	GRAY	FG	16
A3	BLUE	PS+	5
B3	BLUE/BLACK	PS-	6

If the encoder is to be used in absolute mode, a battery must be connected to the [Absolute Encoder Battery Connector](#) on the HVCPU board. See the information on that connector for detailed pin outs and plug types. [Table 5-7](#) contains information on the required battery power.

Table 5-7: Required Battery Power

External Battery Specification	
Maximum voltage	4.75V
Typical voltage	3.6V
Alarm trigger voltage	3.1V

External Battery Specification	
Current for each encoder	3.6 uA

Yaskawa Sigma II/III Serial Absolute Encoder

This section provides wiring instructions for a Yaskawa motor equipped with a Yaskawa Sigma II/III Serial Absolute Encoder. The encoder can have 16-bits (Sigma II), 17-bits (Sigma II/III), 20-bits (Sigma II/III) or 22-bits (Sigma III) of resolution per revolution plus a battery backed-up multiple turns counter. This encoder transmits its position as a serial bit stream via RS-485 lines instead of A-B incremental pulses.

Due to the additional capabilities needed to process the absolute encoder signal, these encoders may require the "Enhanced Encoders" license. Contact Brooks for the current hardware requirements for interfacing to these types of encoders.

For information on configuring this type of encoder, see the Software Setup section of the *Controller Software* section of the *PreciseFlex Library*.

In addition to [Table 5-8](#), review the [Installation Information](#) for important recommendations on the use of twisted pair wires and shield grounding.

Table 5-8: Encoder Connections

Encoder Connector Pin	Wire Color	Signal Name	G6000 Connector Pin
1	RED	5V	4
2	BLACK	GND	7
3	ORANGE	BATTERY +	14
4	WHITE/ORANGE	BATTERY -	12
5	LIGHT BLUE	DATA+	2
6	WHITE/LIGHT BLUE	DATA -	3

Table 5-9: Wiring Instructions for Motor Power Connectors

Motor Connector Pin	Wire Color	Signal Name	G6000 Connector Pins	
			G6400	G6600
1	RED	U	6	1

Motor Connector Pin	Wire Color	Signal Name	G6000 Connector Pins	
			G6400	G6600
2	WHITE	V	2	6
3	BLUE	W	3	5
4	GREEN/YELLOW	FG	5	2
1	RED	BRAKE+	1	8
2	BLACK	BRAKE-	4	4

For the multi-turn counter to operate properly, a battery must be connected to the [Absolute Encoder Battery Connector](#) on the HVCPU board. See the information on that connector for detailed pin outs and plug types. [Table 5-10](#) contains information on the required battery power.

NOTE: Unlike other absolute encoders, the Sigma II/III does not have an internal battery or capacitor that can retain the multi-turn data. Therefore, if the external battery is disconnected while the controller's power is off or the cable from the controller to the encoder is disconnected at any time, the multi-turn data will be lost and the absolute position of the motor and encoder will have to be reestablished.

Table 5-10: Required Battery Power

External Battery Specification	
Typical voltage	3.6V
Alarm trigger voltage	2.7V
Current for each encoder	20 uA

Nikon A/Sanyo Denki Serial Absolute Encoders

This section provides wiring instructions for a motor equipped with a Nikon A 2.5 MHz, a Nikon A 4 MHz, or a Sanyo Denki PA035C 2.5 MHz serial absolute encoder. These encoders transmit their position data using a specialized serial bit stream protocol via a RS-485 pair rather than A-B incremental quadrature pulses. When these encoders are provided with a battery backup source, they function as a high resolution absolute encoder that returns 17-bits of resolution per revolution and a 16-bit "turns count" battery backed-up register for a total of 33-bits of encoder position information.

Due to the additional capabilities needed to process the absolute encoder signal, these encoders may require the "Enhanced Encoders" license. Contact Brooks for the current hardware requirements for interfacing to these types of encoders.

For information on configuring this type of encoder, see the *Software Setup* section of the *Controller Software* section of the *PreciseFlex Library*.

In addition to [Table 5-11](#), review the [Installation Information](#) for important recommendations on the use of twisted pair wires and shield grounding.

Table 5-11: Encoder Connections

Wire Color	Signal Name	G6000 Connector Pin
BROWN	ES +	2
BLUE	ES -	3
RED	5 V	4
BLACK	GND	1
PINK	EBAT +	14
PURPLE	EBAT -	12

For the multi-turn counter to operate properly, a battery must be connected to the [Absolute Encoder Battery Connector](#) on the HVCPU board. See the information on that connector for detailed pin outs and plug types. [Table 5-12](#) contains information on the required battery power.

NOTE: If the external battery is disconnected while the controller's power is off or the cable from the controller to the encoder is disconnected at any time, the multi-turn data may be lost and the absolute position of the motor and encoder will have to be reestablished.

Table 5-12: Required Battery Power

External Battery Specification	
Typical voltage	3.6 V
Alarm trigger voltage	3.0 V

EnDat / SII / BiSS Serial Absolute Encoders

This section provides wiring instructions for motors equipped with one of the following types of serial absolute encoders:

- Heidenhain EQN1135, EnDat 2.2, 23-bits/revolution, 12-bit multiple turns counter
- Heidenhain EQI1130, EnDat 2.1, 18-bits/revolution, 12-bit multiple turns counter
- SSI with n-bit position counter (configurable resolution)
- BiSS-B/BiSS-C with n-bit position counter (configurable resolution)

These encoders transmit their position data using different specialized serial bit stream protocols (via a RS-485 pair) rather than A-B incremental quadrature pulses. Unlike other absolute encoders, these devices also require a second RS-485 pair to transmit a data clocking signal from the controller to the encoder. In general, these encoder types do not require a battery backup source to maintain their multiple turns counter.

Due to the additional capabilities needed to process the absolute encoder signal, these encoders may require the "Enhanced Encoders" license. Contact Brooks for the current hardware requirements for interfacing to these types of encoders.

For information on configuring these types of encoder, see the *Software Setup* section of the *Controller Software* section of the *PreciseFlex Library*.

In addition to [Table 5-13](#), review the [Installation Information](#) for important recommendations on the use of twisted pair wires and shield grounding.

Table 5-13: Encoder Connections

Signal Name	G6000 Connector Pin
DATA +	2
DATA -	3
5V	4
GND	7
CLOCK +	5
CLOCK -	6

Appendix A. Product Specifications

PreciseFlex G6000 Controller Specifications

Table 5-14 contains the specifications for the various models of the PreciseFlex G6000 Controller. "S" indicates a standard feature, "O" indicates an available optional feature, "-" denotes that the feature is not available for a specific controller model and a number indicates the number of facilities available.

Table 5-14: Specifications for PreciseFlex G6000 Controller Models

General Specification	G6600	G6430	G6420	G6410	Range & Features
Computational Hardware					
CPU and Dynamic Memory	S	S	S	S	1 Ghz high performance, low-power CPU with a minimum of 128 MB of dynamic RAM
Nonvolatile Memory	S	S	S	S	Flash disk with a minimum of 64 MB of storage for OS, firmware and user program and data storage
NVRAM	S	S	S	S	32 KBytes of NVRAM for storing key user application dynamic status and state information including error logs
Software					
Programming Interface	S	S	S	S	Three programming methods available: Embedded Guidance Programming Language (GPL) PC/Unix/Linux controlled over Ethernet DIO MotionBlocks (PLC)
Operator Interface	S	S	S	S	Web based operator interface supports local or remote control via browser connected to embedded web server

General Specification	G6600	G6430	G6420	G6410	Range & Features
Motion Control	S	S	S	S	Extensive robotic and low-level motion control available Continuous path following, s-curve profiling Straight-line and circular motions Torque and velocity control Control of up to 32 axes via networked distributed control organized into up to 12 multi-axis robots Distributed control network can consist of up to 16 controllers
	O	O	O	O	Conveyor belt tracking Kinematic models for many robot geometries Advanced Controls License - Enables enhanced motion control modes including: high speed position latching, and real-time trajectory modification.
Machine Vision	O	O	O	O	Provides controller with a complete set of image-processing, measurement, inspection and finder tools. A powerful patented Object Locator finds parts in any orientation and at different scales within milliseconds.
Motion Control					
Motor Drives	6	4	4	4	Number of integrated motor drives Bus voltage 24 VDC to 340 VDC Total power several KW
	-	-	-	S	Current per motor: 10A peak/9 A RMS/9 A stall*
	-	-	S	-	Current per motor: 20A peak/9 A RMS/9 A stall*
	-	S	-	-	Current per motor: 33.3 A peak/9 A RMS/9 A stall*
	S	-	-	-	Current per motor: Axis 1 & 2: 33.3 A peak/9 A RMS/9 A stall* Axis 3 & 4: 20 A peak/9 A RMS/9 A stall* Axis 5 & 6: 10 A peak/9 A RMS/9 A stall* *These values assume adequate heat sinks and forced-air cooling.
Position Sensors Interface	S	S	S	S	Four differential digital encoder interfaces Four configurable single-ended digital encoder interfaces
	O	O	O	O	Support for selected absolute encoders (may require the "Enhanced Encoders" license)

General Specification	G6600	G6430	G6420	G6410	Range & Features
Control Signals	S	S	S	S	Configurable limit stop, home, and hall-effect input signals. Signal lines shared among several functions.
Brake Signals	S	S	S	S	Up to 1 A at 24 VDC available for releasing motor brakes
Communications Interfaces					
Serial Communication	S	S	S	S	RS-232 port with software (no hardware) flow control
Remote Front Panel Interface	S	S	S	S	Remote front panel interface with second RS-232 port (no hardware flow control), compliant with IEC Category 3 (CAT-3) safety standards
Ethernet / EtherCAT Ports	2	2	2	2	100 Mbit Ethernet ports. One ports can be optionally configured to communicate with selected EtherCAT slave smart amplifiers (requires special software license).
Digital Input Channels	S	S	S	S	12 general purpose optically isolated inputs, software configurable in groups of four as sinking or sourcing, signals transition to a high or low in 4 μ sec. 5 VDC to 24 VDC for logic high if sinking 24 VDC supplied for logic high if sourcing
	O	O	O	O	Additional remote I/O available via PreciseFlex RIO modules or 3 rd party MODBUS/TCP devices
Digital Output Channels	S	S	S	S	Eight general purpose optically isolated outputs, individually software configurable as sinking or sourcing, signals turn on in 3 μ sec and turn off within 400 μ sec. 24 VDC maximum pull up if sinking 24 VDC supplied if sourcing 100 mA maximum per channel
	O	O	O	O	Additional remote I/O available via PreciseFlex RIO modules or 3 rd party MODBUS/TCP devices
Multi-Drop Serial I/O	S	S	S	S	RS-485 multi-drop serial communications. Not available on controllers embedded in PreciseFlex Robots
Non-user Accessible IO	S	S	S	-	I2C multi-drop serial communications

General Specification	G6600	G6430	G6420	G6410	Range & Features
USB 2.0	-	-	-	-	Software support for dual USB 2.0 parts not available, future feature
MicroSD Card Slot	-	-	-	-	Software support for MicroSD Card not available, future feature
General					
Size and Weight	-	S	S	S	224 mm (L) x 131.36 mm (W) x 54.50 mm (H), 0.758 kg
	S	-	-	-	294 mm (L) x 151.36 mm (W) x 54.71 mm (H), 1.003 kg
Low Voltage Logic Power	S	S	S	S	24 VDC ±5%, power required for logic and I/O 2.7A minimum 4 A recommended for typical use of digital I/O 1 A additional required for 2 KW PrecisePower Intelligent Motor Power Supply contactors

PreciseFlex G6000 Controller Environmental Specifications

The PreciseFlex G6000 Controllers must be installed in a clean, non-condensing environment with the following specifications.

Table 5-15: Environmental Specifications

General Specification	Range & Feature
Ambient temperature	5° C to 40° C
Storage and shipment temperature	-25° C to +55° C
Humidity range	5 to 90%, non-condensing
Altitude	Up to 3000 m
Free space around controller	6 mm sides and top
Chassis protection class	IP20 (NEMA Type 1)
For EU or EEA countries	IP54, must meet EN 60204 (IEC 204)

PrecisePower 300 Intelligent Motor Power Supply Specifications

Table 5-16: Power Supply Specifications

General Specification	Range & Features
Input Specifications	
Input voltage	90-264 VAC Single phase
Input frequency	50 - 60 Hz
Input inrush current	6.8A at 240 VAC in
Output Specifications	
Output voltage	DC no load = (1.41 X VAC RMS input) - 2 Volts DC full load @ 300 W = (DC no load) X 0.96 DC full load @ 600 W = (DC no load) X 0.93 Nominal range of 167VDC to 337VDC
Output power	300 Watts RMS @ 120 VAC 600 Watts RMS @ 240 VAC
General	
CAT-3	No, does not satisfy these safety requirements for higher power units
Size and Weight	135 mm (L) x 76 mm (W) x 60 mm (H), 0.312 kg
PreciseFlex Part Number	PS1D-EA-00300

PrecisePower 1000 Intelligent Motor Power Supply Specifications

Table 5-17: Power Supply Specifications

General Specification	Range & Features
Input Specifications	
Input voltage	90-240 VAC Single phase
Input frequency	50 - 60 Hz

General Specification	Range & Features
Input inrush current	3.6A at 240 VAC input
Input current	6.2A RMS, 15A peak at 240 VAC single phase & 1000 DC Watts output
Output Specifications	
Output voltage, no load	DC no load = (1.41 X VAC RMS phase-to-phase input) - 2 Volts DC full load single phase = (DC no load) X 0.93 Nominal range of 167 VDC to 337 VDC
Output power	1000 Watts @ 240 VAC single phase input
% Regulation	5 to 7%
Maximum energy dump average power	100 Watts
Peak energy dump voltage	408VDC +/- 2%
Dump release voltage	382VDC +/- 2%
General	
Cat-3	No, does not satisfy these safety requirements for higher power units
Size and Weight	200 mm (L) x 110.3 mm (W) x 60 mm (H), 0.705 kg
PreciseFlex Part Number	PS10-EA-01003

PrecisePower 2000 Intelligent Motor Power Supply Specifications

Table 5-18: Power Supply Specifications

General Specification	Range & Features
Input Specifications	
Input voltage	90-240 VAC Single phase or three phase
Input frequency	50 - 60 Hz
Input inrush current	6.7A at 240 VAC input
Input current	12.4A RMS, 30A peak at 240 VAC single phase & 2000 DC Watts output
Output Specifications	

General Specification	Range & Features
Output voltage, no load	DC no load = (1.41 X VAC RMS phase-to-phase input) - 2 Volts DC full load single phase = (DC no load) X 0.93 DC full load three phase = (DC no load) X 0.97 Nominal range of 167 VDC to 337 VDC
Output power	1000 Watts free air @ 240 VAC single phase input 2000 Watts forced air @ 240 VAC single phase input 2100 Watts forced air @ 208 VAC 3 phase input 3400 Watts forced air @ 240 VAC 3 phase input
% Regulation	5 to 7%
Maximum energy dump average power	100 Watts
Peak energy dump voltage	408VDC +/- 2% (prior to 10/2011: 438VDC +/- 2%)
Dump release voltage	382VDC +/- 2% (prior to 10/2011: 411VDC +/- 2%)
General	
Cat-3	Yes, when used with PreciseFlex software and I2C communication
Fault detection	Output short circuit, output overload, missing third AC phase
Size and Weight	270 mm (L) x 105 mm (W) x 76 mm (H), 0.907 kg
PreciseFlex Part Number	PS10-EA-02000

Appendix B. Frequently Asked Questions (FAQs)

Frequently Asked Questions

This section contains a compilation of frequently asked questions related to the family of PreciseFlex Controllers.

1. [Is there an alternative to purchasing crimping tools for connectors?](#)
2. [How do you connect a robot power enable button?](#)
3. [How do you release the motor brakes in a 1 or 2 axis system?](#)
4. [Why should grippers be wired to release when digital signals are ON?](#)
5. [What are the restrictions on assigning encoder and amplifier channels?](#)

Is there an alternative to purchasing crimping tools for connectors?

If a user does not want to purchase and use the crimping tools required for the various PreciseFlex Controller ribbon cables and would like a convenient means for breaking out the signals, then they can purchase a module that converts a ribbon cable to a terminal block.

The unit displayed below is from Automation Systems Interconnect, Inc. (www.asi-ez.com) and is a "Ribbon Cable Interface Module" Type IMRC. This accepts a standard ribbon cable that can connect to the PreciseFlex Controller via an IDC connector.

For more information on this module, search for "ribbon cable interface module" on the ASI website or "ribbon cable to terminal block converter" on the web.

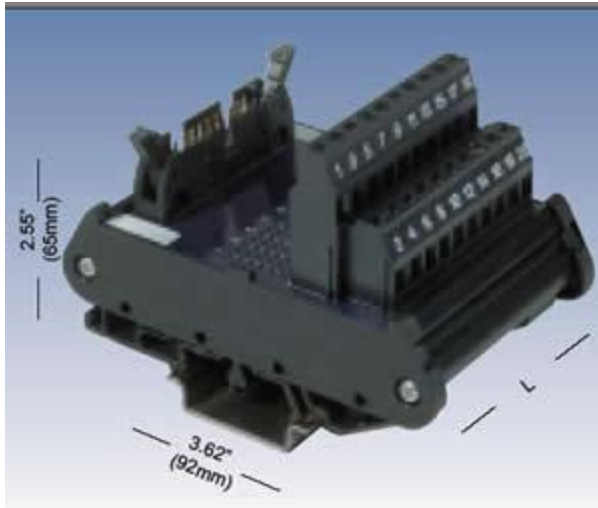

Figure 5-1: Ribbon Cable Interface Module

How do you connect a robot power enable button?

To connect a momentary contact button to enable robot power, wire the button to either a general digital input signal or use the dedicated input signal provided in the Remote Front Panel Connector.

If a user connects the button to a general DIN, the number of the DIN signal should be set as the "Power enable DIN" (DataID 242) parameter database value. If a user connects the button to the Remote Front Panel Connector "High Power On" input, the value of the dedicated input signal (DIN 18007) should be set as the value of DataID 242.

In either case, power will be enabled when the signal toggles from the OFF to the ON state.

How does the user release the motor brakes in a 1 or 2-axis system?

For the integrated motor amplifiers of the PreciseFlex Controllers, the brake signals that are presented in the four or six motor connectors are all tied together internally and are operated by the software that controls the 3rd axis/motor. This works correctly for 3 or 4-axis systems where the 3rd axis is the one that is affected by gravity.

If a system only has one or two axes, to configure the first or second axis to control the brake signals, set the "Auxiliary brake release DOUT channel" (DataID 10625) Parameter Database value for the appropriate axis to "8331." "8331" is the DOUT channel number for the dedicated DIO that controls the brake signal.

Why should grippers be wired to release when digital signals are ON?

Grippers or other tooling should always be wired to digital output signals such that an active (ON) state will release a part. This is an important practice since if the controller loses power and is restarted, all output signals are turned OFF by default. If a gripper is wired to release a part with an OFF signal, any parts left in a gripper from a previous operation would be dropped when the controller is restarted.

What are the restrictions on assigning encoder and amplifier channels?

Due to restrictions in the controller's firmware, in general, the encoder signals used to commutate a motor must be connected to the encoder connector that matches the amplifier connector for the motor. For example, if the leads of a motor are wired to the 2nd amplifier connector, the encoder that commutates the motor must be wired to an input of the 2nd encoder connector. (For all configurations except for dual-loop encoders, a single encoder is utilized to both commutate the motor and close the PID loop.)

For incremental quadrature encoders, the encoder can be interface to either the differential or the single-ended encoder inputs of the required encoder connector. However, the differential inputs are strongly recommended due to their much greater noise immunity.

For the first four serial absolute encoders, encoders from different manufacturers must be connected to specific pins in the required encoder connectors (see the Controller's ["Third Party Equipment Overview" on page 87](#) for more details).

For a 6-axis controller, the absolute encoders for the 5th and 6th motors must be connected to specific pins in the 1st and 2nd encoder connectors, respectively.

Once encoders and motors have been properly wired to controller connectors, the encoder and motor pair can be arbitrarily mapped to logical axes of a robot. For example, an encoder and motor can be wired to the 4th encoder and motor connectors but can be assigned to the 2nd axis of a kinematic module.