

PreciseFlex™ DD 6-Axis



PreciseFlex™ DD 4-Axis

# PreciseFlex™ Direct Drive Robots

## User Manual

Part Number 609741, Revision B

---

# Brooks Automation

Information provided within this document is subject to change without notice, and although believed to be accurate, Brooks Automation assumes no responsibility for any errors, omissions, or inaccuracies.

AcuLigner™, Advan Tag™, AutoTeach™, ATR™, AXM™, BiSymmetrik™, CenterSmart™, Crate to Operate™, CrossingConnect™, DARTS™, Enerta™, e-RMA™, e-Spares™, e-Volution™, Falcon™, FIXLOAD™, FrogLeg™, GuardianPro™, Independent Twin Linear Exchange™, InCooler™, InLigner™, Isoport™, ITLX™, Jet™, Jet Engine™, LEAP™, LeapFrog™, LowProfile™, LPT™, M2 Nano™, Marathon 2, Marathon Express, PASIV™, Pathway™, PowerPak™, PowerTools™, PuroMaxx™, QuadraFly™, Radius™, Radiant™, Radiant Express™, Reliance™, Reliance ATR™, RetroEase™, SCARA™, SmartPM™, SMIF-INX™, SMIF-LPT™, SPOTLevel™, The New Pathway to Productivity™, Time Optimized Trajectory™, Time Optimal Trajectory™, Time Optimized Path™, TopCooler™, TopLigner™, VacuTran™, VersaPort™, WaferEngine™, LEAP™, Pathway™, GIO, GSB, Guidance 6600, Guidance 6430, Guidance 6420, Guidance 6410, Guidance 6000, Guidance 3400, Guidance 3300, Guidance 3200, Guidance 2600, Guidance 2400, Guidance 2300, Guidance 2200, Guidance 1400, Guidance 1300, Guidance 1200, Guidance 0200 Slave Amplifier, Guidance 0006, Guidance 0004, Guidance Controller, Guidance Development Environment, GDE, Guidance Development Suite, GDS, Guidance Dispense, Guidance Input and Output Module, Guidance Programming Language, GPL, Guidance Slave Board, Guidance System, Guidance System D4/D6, PreciseFlex™ 300, PreciseFlex™ 400, PreciseFlex™ 3400, PreciseFlex™ 1300, PreciseFlex™ 1400, PreciseFlex™ DD4, PreciseFlex™ DD6, PreciseFlex™ DDR, PreciseFlex™ G5400, PreciseFlex™ G5600, PreciseFlex™ G6400, PreciseFlex™ G6410, PreciseFlex™ G6420, PreciseFlex™ G6430, PreciseFlex™ G6600, PreciseFlex™ GSBP Slave Amp, PreciseFlex™ PFD0, PrecisePlace 100, PrecisePlace 0120, PrecisePlace 0130, PrecisePlace 0140, PrecisePlace 1300, PrecisePlace 1400, PrecisePlace 2300, PrecisePlace 2400, PrecisePower 300, PrecisePower 500, PrecisePower 1000, PrecisePower 2000, PreciseVision, and RIO logos are trademarks of Brooks Automation.

Fusion®, Guardian®, MagnaTran®, Marathon®, Razor®, Spartan®, Vision®, Zaris®, and the Brooks and design logo are registered U.S. trademarks of Brooks Automation.

All other trademarks are properties of their respective owners.

© 2024 Brooks Automation. All rights reserved. The information included in this manual is proprietary information of Brooks Automation, and is provided for the use of Brooks customers only and cannot be used for distribution, reproduction, or sale without the express written permission of Brooks Automation.

This technology is subject to United States export Administration Regulations and authorized to the destination only; diversion contrary to U.S. law is prohibited.

<p><b>Brooks Automation</b> 15 Elizabeth Drive Chelmsford, MA 01824-2400 Tel: +1 978-262-2400 Fax: +1 978-262-2500</p>	<p><b>Brooks Automation, PreciseFlex Collaborative Robots</b> 201 Lindbergh Avenue Livermore, CA 94551 Tel: +1-408-224-2838</p>
--	---



### Worldwide Headquarters

15 Elizabeth Drive  
Chelmsford, MA 01824 U.S.A.

### Brooks Automation, PreciseFlex Collaborative Robots

201 Lindbergh Avenue  
Livermore, CA 94551 U.S.A

### Technical Support

Location	Contact	Website
North America	+1-800-447-5007 (Toll-Free) +1-978-262-2900 (Local) +1-408-224-2838 (PreciseFlex™)	
Europe	<a href="mailto:support_preciseflex@brooksautomation.com">support_preciseflex@brooksautomation.com</a>	
Japan	+81 120-255-390 (Toll Free) +81 45-330-9005 (Local)	
China	+86 21-5131-7066	<a href="http://www.brooks.com/">http://www.brooks.com/</a>
Taiwan	+886 080-003-5556 (Toll Free) +886 3-5525258 (Local)	
Korea	1800-5116 (Toll Free)	
Singapore	+65 1-800-4-276657 (Toll Free) +65 6309 0701 (Local)	

### General Emails

Division	Email Address
Sales	<a href="mailto:sales_preciseflex@brooksautomation.com">sales_preciseflex@brooksautomation.com</a>
Technical Support	<a href="mailto:support_preciseflex@brooksautomation.com">support_preciseflex@brooksautomation.com</a>
Technical Publications	<a href="mailto:Technical.Publications@brooksautomation.com">Technical.Publications@brooksautomation.com</a>

**Brooks Automation**

15 Elizabeth Drive  
Chelmsford, MA  
01824-2400  
Tel: +1 978-262-2400  
Fax: +1 978-262-2500  
[www.brooks.com](http://www.brooks.com)

## Brooks Locations Worldwide:

**Brooks Automation**

46702 Bayside Parkway  
Fremont, CA 94538  
Tel: +1-510-661-5000  
Fax: +1-510-661-5166

**Brooks Automation**

AIM Servicios Administrativos  
S de RL de CV  
Carretera Huinalá km 2.8  
Parque Industrial Las Américas  
66640 Apodaca, NL Mexico  
Tel: +52 81 8863-6363

**Brooks Automation (Germany) GmbH**

Ernst-Ruska-Ring 11  
07745 Jena, Germany  
Tel: +49 3641 4821 100  
Fax: +49 3641 4821 4100

**Brooks Automation (Germany) GmbH**

Daimler-Straße 7  
78256 Steißlingen, Germany  
Tel: +49-7732-9409-0  
Fax: +49-7732-9409-200

**Brooks Automation**

9601 Dessau Road, Suite 301  
Austin, TX 78754  
Tel: +1 512-912-2840  
Toll-Free: +1 800-367-4887

**Brooks Automation (Israel) Ltd.**

Mevo Yerach 5  
Kiryat-Gat 82000  
Israel  
Tel: +972 8672 2988  
Fax: +972 8672 2966

**Brooks Technology (Shanghai) Limited**

2nd Floor, No. 72,  
887 Zuchongzhi Road  
Zhangjiang Hi-Tech  
Park Pudong, Shanghai  
China 201203  
Tel: +86-21-5131-7070  
Fax: +86-21-5131-7068

**Brooks Japan K.K.**

HEADQUARTERS  
Nisso Bldg. No 16, 9F  
3-8-8 ShinYokohama, Kohoku-ku  
Yokohama, Kanagawa 222-0033  
Tel: +81-45-477-5570  
Fax: +81-45-477-5571

**Brooks Japan K.K.**

YOKOHAMA TECHNICAL  
CENTER  
852-1 Kawamuko-cho, Tsuzuki-ku  
Yokohama, Kanagawa 224-0044  
Tel: +81-45-477-5250  
Fax: +81-45-470-6800

**Brooks Japan K.K.**

KUMAMOTO SERVICE OFFICE  
202 Mirai Office II  
312-1 Tatsudamachi Yuge  
Tatsuda, Kumamoto 861-8002  
Tel: +81-96-327-9720  
Fax: +81-96-327-9721

**Brooks CCS Japan K.K.**

CONTAMINATION CONTROL  
SOLUTIONS  
Nisso Bldg. No 16, 9F  
3-8-8 ShinYokohama, Kohoku-ku  
Yokohama, Kanagawa 222-0033  
Tel: +81-45-477-5570  
Fax: +81-45-477-5571

**Brooks Automation Ltd.**

TAIWANHEADQUARTERS  
5F-5, No.32, Tai-Yuen Street  
Chu-Pei City  
Hsinchu County 302, Taiwan,  
R.O.C.  
Tel: +886-3-552 5258  
Fax (G&A): +886-3-552 5255  
Fax (Sales): +886-3-552 5200

**Brooks Automation Korea, Inc.**

#35 Giheungdanji-Ro 121Beon-  
Gil  
Giheung-Gu, Yongin-Si  
Gyeonggi-Do, 17086  
Korea  
Tel: +82-31-288-2500  
Fax: +82-31-287-2111

**Brooks Automation CCS RS AG**

Lohstampfstrasse 11  
CH-8274 Tagerwilen, Switzerland  
Tel: + 41 71-666-72-10  
Fax: + 41 71-666-72-11

**Brooks Automation Korea**

#35 Giheungdanji-Ro 121Beon-  
Gil  
Giheung-Gu, Yongin-Si  
Gyeonggi-Do, 17086  
Korea  
Tel: +82-31-288-2500  
Fax: +82-31-287-2111

**Brooks Automation (S) Pte Ltd**

51-18-C1 Menara BHL,  
57 Jalan Ahmad Shah,  
10050, Penang,  
Malaysia  
Tel: +60 4 3701012  
Fax: +60 4 3701015

**Brooks Automation (Singapore) Pte Ltd**

Blk 5008 Ang Mo Kio Avenue 5  
#05-08, Techplace II  
Singapore 569874  
Tel: +65-6836-3168  
Fax: +65-6836-3177

**Brooks Automation Ltd.**

TAINAN OFFICE  
3F., No.11, Nanke 3rd Rd., Xinshi  
Dist.  
Tainan Science Park  
Tainan City 74147, Taiwan  
(R.O.C.)  
TEL: +886-6-505-0268  
FAX: +886-6-505-5228

**Brooks Automation Precise Collaborative Robotics**

201 Lindbergh Drive  
Livermore, CA 94551  
Tel: +1-978-262-2400

## Revision History

Revision	ECO	Date	Action	Author
A	EC147369	2/2/2024	Released manual at Rev. A to follow standard Brooks technical publication styles.	M. Ashenfelder
B	EC154071	4/19/2024	Revision A was split into two manuals: the User Manual and Service Manual. Graphics revised.	M. Ashenfelder

# Table of Contents

<b>1. Safety</b> .....	<b>1</b>
Safety Setup .....	1
Authorized Personnel Only .....	1
Explanation of Hazards and Alerts .....	2
Safety Text .....	2
Safety Icons .....	2
Signal Words and Color .....	2
Alert Example .....	3
General Safety Considerations .....	4
Mechanical Hazards .....	6
Electrical Hazards .....	7
Ergonomic Hazards .....	8
Emergency Stop Circuit (E-Stop) .....	10
Recycling and Hazardous Materials .....	10
<b>2. Collaborative Robot Safety</b> .....	<b>11</b>
Overview .....	11
Definitions and Acronyms Used in this Chapter .....	12
Testing Setup .....	13
Measurement of Pressure and Force .....	15
Selecting the Forces .....	15
Evaluating the Test Results .....	18
Collision Testing .....	18
Transient Contact Test Procedure .....	18
Quasi-Static Contact Test Procedure .....	20
Collision Testing - Comparison of Plastic and Foam Covers .....	21
Conclusion .....	22
<b>3. Introduction to the Hardware</b> .....	<b>23</b>
System Overview and Description .....	23
Explanation of the Product Label .....	24
Example Sections from the Product Label .....	25
P/N - Part Number .....	27
Serial Number (SN) .....	28
Facilities Panel .....	29
PFDD Robots .....	31
System Diagram and Coordinate Systems .....	32
Control System Overview .....	34
Power Supplies and Power Considerations .....	35
Energy Dump Circuit .....	35
Remote Front Panel, E-Stop Box and Manual Control Pendant .....	36
Remote IO Module (Ethernet Version) .....	36
Machine Vision Software and Cameras .....	37
Machine Safety .....	37
Safety and Agency Certifications .....	37

Standards Compliance and Agency Certifications .....	38
Moving Machine Safety .....	38
Mechanical and Software Limit Stops .....	38
Stopping Time and Distance .....	39
Safety Zones .....	40
Releasing a Trapped Operator: Brake Release Switch .....	45
<b>3. Installation Information .....</b>	<b>46</b>
Environmental Specifications .....	46
Setup and Operation .....	46
Unpacking and Handling Instructions .....	46
Mounting Instructions .....	46
Tool Mounting .....	47
ISO Flange for End-of-Arm Tooling .....	48
System Dimensions .....	49
Work Envelope .....	52
Accessing the Robot Controller .....	53
Power Requirements .....	54
Emergency Stop .....	54
<b>4. Hardware Reference .....</b>	<b>55</b>
E-stop Connector .....	55
MCP/E-stop Interface .....	55
Digital Input and Output Signals .....	57
Digital Input Signals .....	57
Digital Output Signals .....	58
25-Pin D-Sub Signals .....	59
Slave Amplifier (GSBP) Digital Inputs and Outputs .....	60
Ethernet Interface .....	61
RS-232 Serial Interface .....	61
Gripper Serial Interface (for Bar Code and other RS232 devices in Gripper) .....	62
<b>5. Software Reference .....</b>	<b>63</b>
Accessing the Web Server .....	63
Loading a Project (Program) or Updating PAC Files .....	65
Updating GPL (System Software and Firmware) .....	66
Recovering from Corrupted PAC Files .....	67
<b>Appendices .....</b>	<b>69</b>
Appendix A: PFDD4 Product Specifications .....	70
Appendix B: PFDD6 Product Specifications .....	72
Appendix C: Environmental Specifications .....	74
Appendix D: Spare Parts List .....	75
Appendix E: Preventative Maintenance .....	76
Appendix F: Unpacking the Robot .....	77
Appendix G: Safety Circuits for PFDD Robots .....	80
Appendix H: Example Performance Level Evaluation for the PFDD .....	82
Appendix I: Table A2 from ISO/TS 15066: 2016 .....	83
Appendix J: ISO TS 15066 Test Results, Transient Contact .....	85



Appendix K: ISO TS 15066 Test Results, Quasi-Static Contact .....	87
Appendix L: Comparison of Plastic and Foam Covers .....	89
Impact Force .....	89
Arm Dimensions .....	91



# 1. Safety

## Safety Setup

Brooks uses caution, warning, and danger labels to convey critical information required for the safe and proper operation of the hardware and software. Read and comply with all labels to prevent personal injury and damage to the equipment.

 <b>DANGER</b> Read the Safety Chapter	
<p>Failure to review the <i>Safety</i> chapter and follow the safety warnings can result in serious injury or death.</p> <ul style="list-style-type: none"><li>• All personnel involved with the operation or maintenance of this product must read and understand the information in this safety chapter.</li><li>• Follow all applicable safety codes of the facility as well as national and international safety codes.</li><li>• Know the facility safety procedures, safety equipment, and contact information.</li><li>• Read and understand each procedure before performing it.</li></ul>	

## Authorized Personnel Only

This product is intended for use by trained and experienced personnel. Operators must comply with applicable organizational operating procedures, industry standards, and all local, regional, national, and international laws and regulations.

## Explanation of Hazards and Alerts

This manual and this product use industry standard hazard alerts to notify the user of personal or equipment safety hazards. Hazard alerts contain safety text, icons, signal words, and colors.

### Safety Text

Hazard alert text follows a standard, fixed-order, three-part format.





- Identify the hazard
- State the consequences if the hazard is not avoided
- State how to avoid the hazard.

### Safety Icons

- Hazard alerts contain safety icons that graphically identify the hazard.
- The safety icons in this manual conform to ISO 3864 and ANSI Z535 standards.

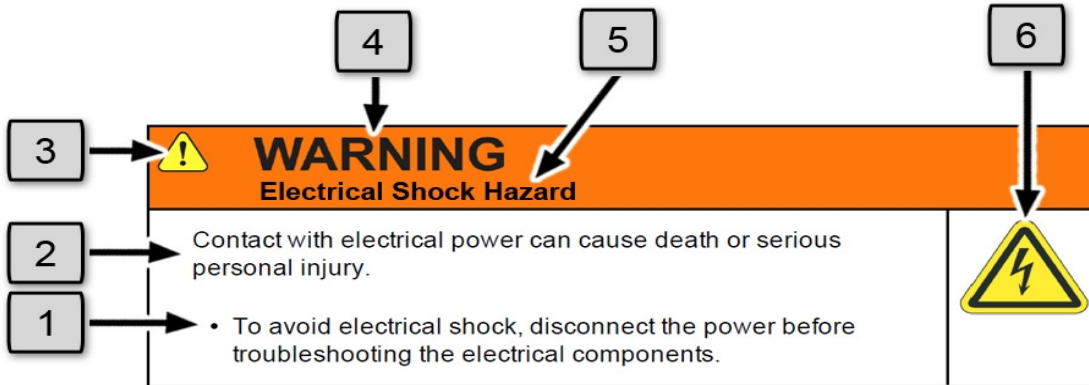
### Signal Words and Color

Signal words inform of the level of hazard.

	<p>Danger indicates a hazardous situation which, if not avoided, <b>will result in serious injury or death.</b></p> <p>The Danger signal word is white on a red background with an exclamation point inside a yellow triangle with black border.</p>
	<p>Warning indicates a hazardous situation which, if not avoided, <b>could result in serious injury or death.</b></p> <p>The Warning signal word is black on an orange background with an exclamation point inside a yellow triangle with black border.</p>
	<p>Caution indicates a hazardous situation or unsafe practice which, if not avoided, <b>may result in minor or moderate personal injury.</b></p> <p>The Caution signal word is black on a yellow background with an exclamation point inside a yellow triangle with black border.</p>
	<p>Notice indicates a situation or unsafe practice which, if not avoided, <b>may result in equipment damage.</b></p> <p>The Notice signal word is white on blue background with no icon.</p>




## Alert Example



The following is an example of a Warning hazard alert.







Number	Description
1.	How to Avoid the Hazard
2.	Source of Hazard and Severity
3.	General Alert Icon
4.	Signal Word
5.	Type of Hazard
6.	Hazard Symbol(s)



## General Safety Considerations



 <b>WARNING</b> Software	
<p>Software is not safety rated. Unplanned motion can occur as long as power is supplied to the motors. Maximum torque could be momentarily applied that may cause equipment damage or personal injury.</p> <ul style="list-style-type: none"><li>• Only operate the robot with its covers installed.</li><li>• Guarantee that safety controller features are in place (for example, an emergency stop button and protective stop).</li><li>• Regularly test safety components to prove that they function correctly.</li></ul>	 



 <b>WARNING</b> Robot Mounting	
<p>Before applying power, the robot must be mounted on a rigid test stand, secure surface, or system application. Improperly mounted robots can cause excessive vibration and uncontrolled movement that may cause equipment damage or personal injury.</p> <ul style="list-style-type: none"><li>• Always mount the robot on a secure test stand, surface, or system before applying power.</li></ul>	



 <b>WARNING</b> Do Not Use Unauthorized Parts	
<p>Using parts with different inertial properties with the same robot application can cause the robot's performance to decrease and potentially cause unplanned robot motion that could result in serious personal injury.</p> <ul style="list-style-type: none"><li>• Do not use unauthorized parts.</li><li>• Confirm that the correct robot application is being used.</li></ul>	

 <b>WARNING</b> <b>Magnetic Field Hazard</b>	
<p>This product contains magnetic motors that can be hazardous to implanted medical devices, such as pacemakers, and cause personal harm, severe injury, or death.</p> <ul style="list-style-type: none"><li>• Maintain a safe working distance of 30 cm from the motor when with an energized robot if you use a cardiac rhythm management device.</li></ul>	



 <b>CAUTION</b> <b>Unauthorized Service</b>	
<p>Personal injury or damage to equipment may result if this product is operated or serviced by untrained or unauthorized personnel.</p> <ul style="list-style-type: none"><li>• Only qualified personnel who have received certified training and have the proper job qualifications are allowed to transport, assemble, operate, or maintain the product.</li></ul>	


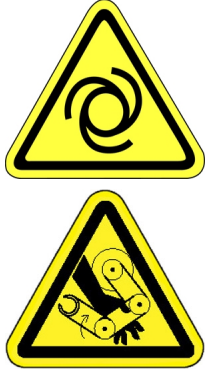
 <b>CAUTION</b> <b>Damaged Components</b>	
<p>The use of this product when components or cables appear to be damaged may cause equipment malfunction or personal injury.</p> <ul style="list-style-type: none"><li>• Do not use this product if components or cables appear to be damaged.</li><li>• Place the product in a location where it will not get damaged.</li><li>• Route cables and tubing so that they do not become damaged and do not present a personal safety hazard.</li></ul>	



 <b>CAUTION</b> <b>Inappropriate Use</b>	
<p>Use of this product in a manner or for purposes other than for what it is intended may cause equipment damage or personal injury.</p> <ul style="list-style-type: none"><li>• Only use the product for its intended application.</li><li>• Do not modify this product beyond its original design.</li><li>• Always operate this product with the covers in place.</li></ul>	

 <b>CAUTION</b> <b>Seismic Restraint</b>	
<p>The use of this product in an earthquake-prone environment may cause equipment damage or personal injury.</p> <ul style="list-style-type: none"> <li>The user is responsible for determining whether the product is used in an earthquake prone environment and installing the appropriate seismic restraints in accordance with local regulations.</li> </ul>	

## Mechanical Hazards



 <b>CAUTION</b> <b>Pinch Point</b>	
<p>Moving parts of the product may cause squeezing or compression of fingers or hands resulting in personal injury.</p> <ul style="list-style-type: none"> <li>Do not operate the product without the protective covers in place.</li> </ul>	



 <b>WARNING</b> <b>Automatic Movement</b>	
<p>Whenever power is applied to the product, there is the potential for automatic or unplanned movement of the product or its components, which could result in personal injury.</p> <ul style="list-style-type: none"> <li>Follow safe practices for working with energized products per the facility requirements.</li> <li>Do not rely on the system software or process technology to prevent unexpected product motion.</li> <li>Do not operate the product without its protective covers in place.</li> <li>While the collaborative robotics system is designed to be safe around personnel, gravity and other factors may present hazards and should be considered.</li> </ul>	



 <b>CAUTION</b> Vibration Hazard	
<p>As with any servo-based device, the robot can enter a vibratory state resulting in mechanical and audible hazards. Vibration indicates a serious problem. Immediately remove power.</p> <ul style="list-style-type: none"><li>• Before energizing, ensure the robot is bolted to a rigid metal chamber or stand.</li></ul>	

## Electrical Hazards

Refer to the specifications of the *Guidance Controller Quick Start Guide* for the electrical power.



 <b>DANGER</b> Electrical Shock Hazard	
<p>Contact with electrical power can cause personal harm and serious injury.</p> <ul style="list-style-type: none"><li>• To avoid electrical shock, disconnect the power before troubleshooting the electrical components.</li><li>• Check the unit's specifications for the actual system power requirements and use appropriate precautions.</li><li>• Never operate this product without its protection covers on.</li></ul>	



 <b>WARNING</b> Electrical Burn	
<p>Improper electrical connection or connection to an improper electrical supply can result in electrical burns resulting in equipment damage, serious injury, or death.</p> <ul style="list-style-type: none"><li>• Always provide the robot with the proper power supply connectors and ground that are compliant with appropriate electrical codes.</li></ul>	

 <b>WARNING</b> <b>Electrical Fire Hazard</b>	
<p>All energized electrical equipment poses the risk of fire, which may result in severe injury or death. Fires in wiring, fuse boxes, energized electrical equipment, computers, and other electrical sources require a Class C extinguisher.</p> <ul style="list-style-type: none"> <li>Use a fire extinguisher designed for electrical fires (Class C in the US and Class E in Asia).</li> <li>It is the facility's responsibility to determine if any other fire extinguishers are needed for the system that the robot is in.</li> </ul>	



<b>NOTICE</b>	
<p>Improper handling of the power source or connecting devices may cause component damage or equipment fire.</p> <ul style="list-style-type: none"> <li>Connect the system to an appropriate electrical supply.</li> <li>Turn off the power before servicing the unit.</li> <li>Turn off the power before disconnecting the cables.</li> </ul>	

## Ergonomic Hazards

 <b>CAUTION</b> <b>Heavy Lift Hazard</b>	
<p>Failure to take the proper precautions before moving the robot could result in back injury and muscle strain.</p> <ul style="list-style-type: none"> <li>Use a lifting device and cart rated for the weight of the drive or arm.</li> <li>Only persons certified in operating the lifting device should be moving the product.</li> </ul>	



 <b>CAUTION</b> <b>Tipover Hazard</b>	
<p>This product has a high center of gravity which may cause the product to tip over and cause serious injury.</p> <ul style="list-style-type: none"> <li>Always properly restrain the product when moving it.</li> <li>Never operate the robot unless it is rigidly mounted.</li> </ul>	



 <b>CAUTION</b> <b>Trip Hazard</b>	
<p>Cables for power and communication and facilities create trip hazards which may cause serious injury.</p> <ul style="list-style-type: none"><li>• Always route the cables where they are not in the way of traffic.</li></ul>	

## Emergency Stop Circuit (E-Stop)

The integrator of the robot must provide an emergency stop switch.

 <b>WARNING</b> Emergency Stop Circuit	
<p>Using this product without an emergency stop circuit may cause personal injury.</p> <ul style="list-style-type: none"><li>• Customer is responsible for integrating an emergency stop circuit into their system.</li><li>• Do not override or bypass the emergency stop circuit.</li></ul>	

## Recycling and Hazardous Materials

Brooks Automation complies with the EU Directive 2002/96/EU Waste Electrical and Electronic Equipment (WEEE).

The end user must responsibly dispose of the product and its components when disposal is required. The initial cost of the equipment does not include cost for disposal. For further information and assistance in disposal, please email Brooks Automation Technical Support at [support@preciseflex@brooksautomation.com](mailto:support@preciseflex@brooksautomation.com).

## 2. Collaborative Robot Safety

### Overview

PreciseFlex™ robots control the force and pressure they exert on their surroundings. Brooks tests its robots to guarantee the robots will stop their motion if they exceed the threshold of safety to humans. The testing process was done in accordance with RIA TR R15.806, which provides guidance on how to perform verification on measuring pressures and forces due to collaborative application contact situations. Note that not all collaborative applications are the same. We recommend performing a risk assessment to establish performance level and guarding that may be required. This chapter presents the methods Brooks used to test PreciseFlex PFDD Robots as Power and Force Limited (PFL) robots against bio-mechanical limits provided by ISO/TS 15066.

---

**NOTE:** A robot with PFL functionality is not to be considered safe “out of the box” as the PFL robot is a component within a collaborative application. Additionally, human-to-robot collaboration relates to the robotic application and not to the robot alone.

---

The International Organization for Standardization (ISO) has published several standards related to collaborative robots, or cobots, including safety requirements and guidelines. Therefore, cobots can be made ISO compliant by meeting the relevant standards and guidelines. Some of the ISO standards related to cobots include:

- ISO 10218-1 and ISO 10218-2: These standards specify safety requirements for industrial robots and cobots. They cover topics such as risk assessment, protective measures, and safety distances.
- ISO 12100: This standard provides a general framework for risk assessment and risk reduction for machinery and equipment, including cobots.
- ISO/TS 15066: This technical specification provides guidelines for the safe implementation of cobots. It includes recommendations for risk assessment, design and control of cobots, and training of operators.

[ISO/TS 15066:2016](#) (*Robots and Robotic Devices - Collaborative Robots*) has been adopted in the US as Technical Report RIA TR 15.606 but does not describe how to measure pressures and forces due to collaborative application contact situations. However, [RIA TR 15.806](#) (*Industrial Robots and Robot Systems - Safety Requirements - Testing Methods for Power & Force Limited Collaborative Applications*) provides guidance on testing verification, and Brooks used it as a testing reference on how to measure pressures and forces that may result from contact between a robot and a human operator.

---

**NOTE:** RIA TR 15.606 supports [ISO 10218-1](#) (*Robots and robotic devices — Safety requirements for industrial robots*) and [ISO 10218-2](#) (*Robot systems and integration*).

---

Brooks analyzed the measured forces and pressures to determine whether they were within allowable limits specified in ISO/TS 15066. Brooks conducted additional testing on the robot to verify its compliance with other safety requirements specified in ISO 10218-1 and ISO 10218-2. These tests included verifying the robot's emergency stop function and assessing its ability to detect and respond to unexpected obstacles. This chapter presents the testing methods Brooks used.

---

**NOTE:** Meeting these ISO standards can help ensure that a cobot is safe to operate and can perform its intended tasks without posing a risk to human operators. However, it is important to note that ISO compliance alone does not guarantee safety, and other factors such as proper installation, maintenance, and operator training are also important for ensuring safe cobot operation.

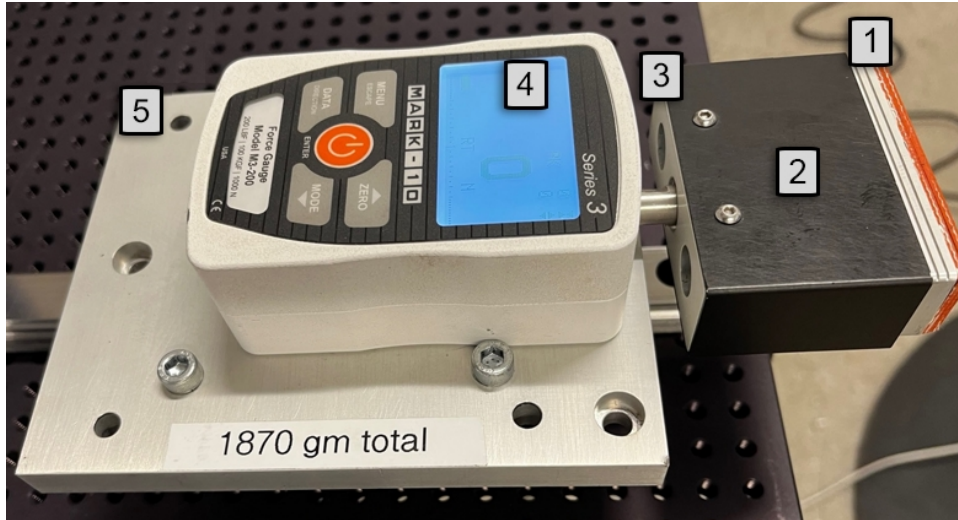
---

## Definitions and Acronyms Used in this Chapter

- **PFMD:** Pressure and/or Force Measurement Device
- **K1:** Damping property of a test device associated with a specific human body region
- **K2:** Spring constant associated with a specific human body region
- **Quasi-Static Contact:** Contact between an operator and part of a robot system where the operator body part can be clamped between a moving part of a robot system and another fixture or moving part of the robot cell
- **Transient Contact:** Contact between an operator and part of the robot system where the operator body part is not clamped and can recoil or retract from the moving part of the robot system.

## Testing Setup

A certified, calibrated force gauge was attached to a mounting table and test stand to measure the force of impact vertically and horizontally.



**Force Gauge, Setup**

**Force Gauge Setup, Key**

Number	Description
1.	Damping - K-1
2.	Spring - K-2
3.	Moving Plate
4.	Force Sensor
5.	Base

A robot was set up so that its arm repeatedly hit the force gauge, and the pressure and force of the impact were measured.



**Robot, Gripper, and Force Gauge Setup**

**Robot, Gripper, and Force Gauge Setup - Key**

Number	Description
1.	Mounting Table
2.	Force Gauge
3.	Payload
4.	Robot
5.	Gripper

## Measurement of Pressure and Force

Testing is usually done in the horizontal- and vertical directions. Since gravity adds to the force in the downwards vertical direction, and since in the horizontal plane forces are symmetric in opposite directions, testing in +X, +Y, and -Z (downwards) is generally sufficient to characterize robot forces.

A “compliance plate” assembly is attached to the robot to simulate the compliance of the human hand -- the threshold of comfort -- of 75 N/mm, based on Table A.3 ISO/TS 15066, Annex A (Figure 2-1).

Body region	Effective spring constant	Effective mass
	$K$ N/mm	$m_H$ kg
Skull and forehead	150	4,4
Face	75	4,4
Neck	50	1,2
Back and shoulders	35	40
Chest	25	40
Abdomen	10	40
Pelvis	25	40
Upper arms and elbow joints	30	3
Lower arms and wrist joints	40	2
Hands and fingers	75	0,6
Thighs and knees	50	75
Lower legs	60	75

NOTE Mass values for thighs, knees and lower legs are set to the full body weight, since these body parts are not free to recoil or retract from impact while the operator is standing.

Figure 2-1: Table A.3 - Effective Masses & Spring Constants for the Body Model

### Selecting the Forces

Clamping/squeezing force is measured by moving the robot slowly into the force gauge until the robot reaches its maximum force and generates an error. Based on Table A.2 (see [Table A2 from ISO/TS 15066: 2016](#)), Brooks selected the maximum clamping force (quasi-static) to be 140 N for a collaborative robot (Figure 2-2).

Body region	Specific body area		Quasi-static contact		Transient contact	
			Maximum permissible pressure <sup>a</sup> $p_s$ N/cm <sup>2</sup>	Maximum permissible force <sup>b</sup> N	Maximum permissible pressure multiplier <sup>c</sup> $P_T$	Maximum permissible force multiplier <sup>c</sup> $F_T$
Hands and fingers	17	Forefinger pad D	300	140	2	2
	18	Forefinger pad ND	270		2	
	19	Forefinger end joint D	280		2	
	20	Forefinger end joint ND	220		2	
	21	Thenar eminence	200		2	
	22	Palm D	260		2	
	23	Palm ND	260		2	
	24	Back of the hand D	200		2	
Thighs and knees	26	Thigh muscle	250	220	2	2
	27	Kneecap	220	2	2	
Lower legs	28	Middle of shin	220	130	2	2
	29	Calf muscle	210	2	2	

Figure 2-2: Table A.2 - Biomechanical Limits, Maximum Quasi-Static Force of 140 N

Transient impact force in free space is measured by moving the robot at its maximum permitted speed and payload with the compliance plate impacting the force sensor when the force sensor is held by a person in free space. Based on Table A.2 from ISO/TS 15066, Brooks has selected the maximum impact force (transient force) in free space to be 280 N for the hand and forearm (see Figure 2-3) and 130 N for the skull (see Figure 2-4) for a collaborative robot.

Body region	Specific body area		Quasi-static contact		Transient contact	
			Maximum permissible pressure <sup>a</sup> $p_s$ N/cm <sup>2</sup>	Maximum permissible force <sup>b</sup> N	Maximum permissible pressure multiplier <sup>c</sup> $P_T$	Maximum permissible force multiplier <sup>c</sup> $F_T$
Hands and fingers	17	Forefinger pad D	300	140	2	2
	18	Forefinger pad ND	270		2	
	19	Forefinger end joint D	280		2	
	20	Forefinger end joint ND	220		2	
	21	Thenar eminence	200		2	
	22	Palm D	260		2	
	23	Palm ND	260		2	
	24	Back of the hand D	200		2	
Thighs and knees	26	Thigh muscle	250	220	2	2
	27	Kneecap	220	2	2	
Lower legs	28	Middle of shin	220	130	2	2
	29	Calf muscle	210	2	2	

Figure 2-3: Table A.2 - Biomechanical Limits, Maximum Force for Hand & Forearm



Body region	Specific body area		Quasi-static contact		Transient contact	
			Maximum permissible pressure <sup>a</sup> $p_s$ N/cm <sup>2</sup>	Maximum permissible force <sup>b</sup> N	Maximum permissible pressure multiplier <sup>c</sup> $P_T$	Maximum permissible force multiplier <sup>c</sup> $F_T$
Skull and forehead <sup>d</sup>	1	Middle of forehead	130	130	not applicable	not applicable
	2	Temple	110		not applicable	
Face <sup>d</sup>	3	Masticatory muscle	110	65	not applicable	not applicable
Neck	4	Neck muscle	140	150	2	2
	5	Seventh neck muscle	210		2	
Back and shoulders	6	Shoulder joint	160	210	2	2
	7	Fifth lumbar vertebra	210		2	2
Chest	8	Sternum	120	140	2	2
	9	Pectoral muscle	170		2	
Abdomen	10	Abdominal muscle	140	110	2	2
Pelvis	11	Pelvic bone	210	180	2	2
Upper arms and elbow joints	12	Deltoid muscle	190	150	2	2
	13	Humerus	220		2	
Lower arms and wrist joints	14	Radial bone	190	160	2	2
	15	Forearm muscle	180		2	
	16	Arm nerve	180		2	

Figure 2-4: Table A.2 - Biomechanical Limits, Maximum Force for the Skull

Table 2-1 shows test configurations that Brooks performed, the speed that was applied, and on which joints.

Table 2-1: Tests Performed

Speed (%)	TRANSIENT CONTACT				QUASI-STATIC CONTACT			
	Joint 1	Joint 3	XY	Z	Joint 1	Joint 3	XY	Z
10	√	√	√	√	√	√	√	√
20	√	√	√	√	√	√	√	√
30	√	√	√	√	√	√	√	√
40	√	√	√	√	√	√	√	√
50	√	√	√	√	√	√	√	√
60	√	√	√	√	√	√	√	√
70	√	√	√	√	√	√	√	√
80	√	√	√	√	√	√	√	√
90	√	√	√	√	√	√	√	√
100	√	√	√	√	√	√	√	√

## Evaluating the Test Results

Figure 2-5 represents acceptable force levels for when executing transient contact. It shows what force or pressure -- transient or quasi-static -- is allowable within half a second. The orange region of Figure 2-5 shows the force or pressure that exceeds the limit. Refer to [ISO/TS 15066](#).

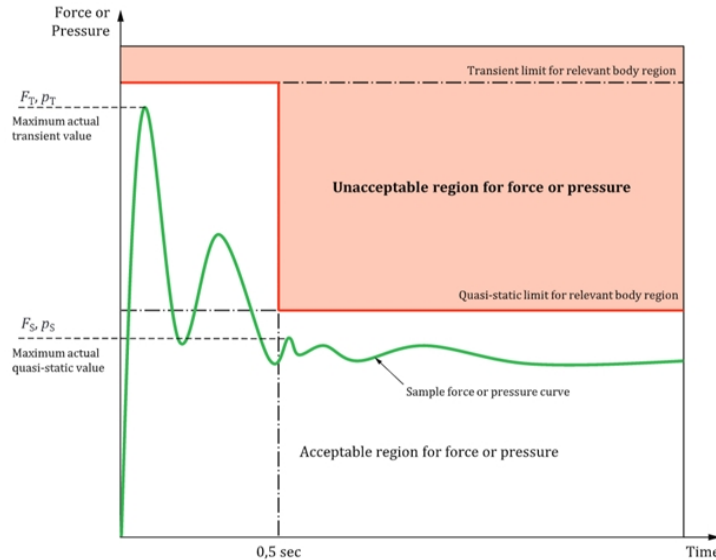


Figure 2-5: Acceptable Force Levels for Transient Contact

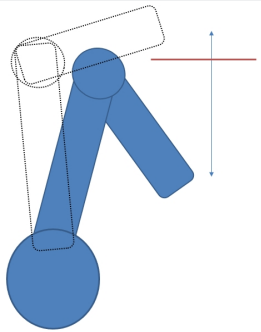
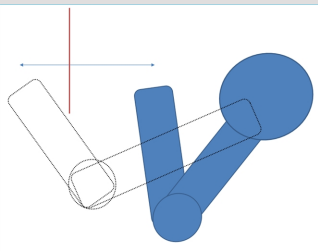
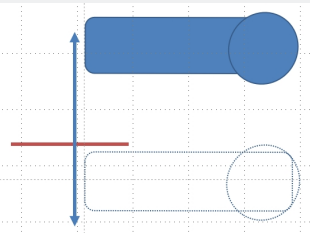
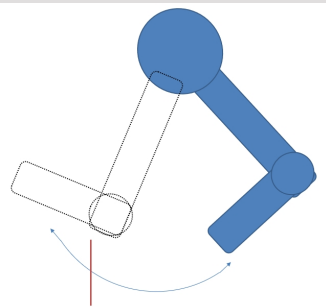
See [ISO TS 15066 Test Results, Transient Contact](#) and [ISO TS 15066 Test Results, Quasi-Static Contact](#) for acceptable force levels.

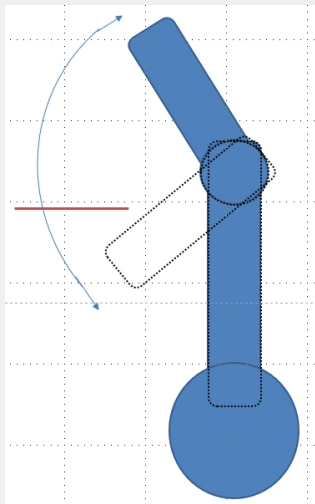
## Collision Testing

### Transient Contact Test Procedure

The force measurement device was mounted on a slide (transient contact). The measurement device mass equals 1.9 kg (equivalent of lower arm and wrist). The impact location was selected as if an operator was in contact with the robot arm far enough to bounce away, and it was as close as possible to constant velocity region of the motion. See [Table 2-2](#).

**Table 2-2: Transient Contact**

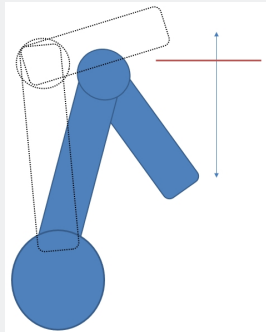
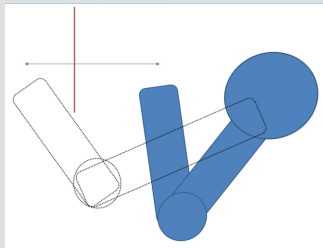
Joint/Axis	Arm	Procedure
X-axis		<p>Commanded end position 50 mm after impact point</p>
Y-axis		<p>Commanded end position 50 mm after impact point</p>
Z-axis		<p>Commanded end position 50 mm after impact point</p>
J1		<p>Commanded end position 15 deg (150 mm at 550 mm radius) after impact point</p>

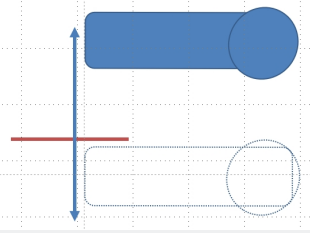
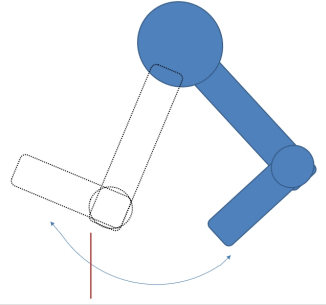
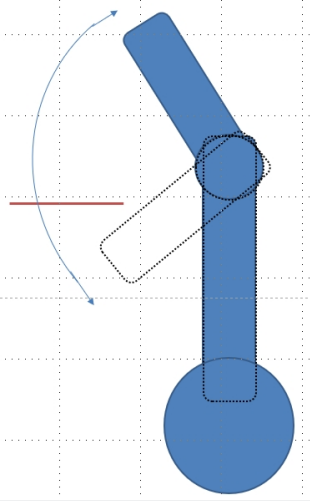
Joint/Axis	Arm	Procedure
J3		Commanded end position 15 deg (92 mm at 350 mm radius) after impact point

### Quasi-Static Contact Test Procedure

The impact location was selected as if an operator was in contact with the robot arm close to the end location (trapped). See [Table 2-3](#).

**Table 2-3: Quasi-Static Contact**

Joint/Axis	Arm	Procedure
X-axis		Commanded end position 35 mm after impact point
Y-axis		Commanded end position 35 mm after impact point

Joint/Axis	Arm	Procedure
Z-axis		<p>Commanded end position 20 mm after impact point</p>
J1		<p>Commanded end position 1.5 deg (15 mm at 550 mm radius) after impact point</p>
J3		<p>Commanded end position 15 deg (92 mm at 350 mm radius) after impact point</p>

## Collision Testing - Comparison of Plastic and Foam Covers

Brooks updated the covers for the PreciseFlex Direct Drive from foam to plastic. For impact testing and arm dimensions, see **Appendix M: [Comparison of Plastic and Foam Covers](#)**.

## Conclusion

All of the transient collision tests that Brooks performed with listed speeds/accelerations were within the ISO 15066 recommended guidelines. UL Solutions performed the witness testing.



For quasi-static testing, it is recommended to dynamically reduce speeds and accelerations when moving in the downward Z-direction.

For detailed results information, see [ISO TS 15066 Test Results, Transient Contact](#) and [ISO TS 15066 Test Results, Quasi-Static Contact](#).

## 3. Introduction to the Hardware

### System Overview and Description

The PFDD Direct Drive Robots are available in either a 4-axis or 6-axis configuration. Both robots include embedded motion controllers, a 48 VDC motor power supply, and a 24 VDC logic power supply located inside the robot. In addition, they may optionally include an electric gripper and electric gripper controller, or solenoid valves to support pneumatic grippers.

The Z-axis of these robots is available with a standard travel of 500 mm, and optional travels of 1000 mm and 1420 mm. The 6-axis robot can carry a payload of up to 5 kg and the 4-axis robot can carry a payload up to 7.0 kg. These robots are extremely quiet and smooth, very reliable, and have excellent positioning repeatability. To achieve these results, the axes are powered by brushless DC motors with absolute encoders. With these characteristics, these robots are ideal for automating applications in the Life Sciences, Medical Products, Semiconductor, Automotive, and Electronics industries.

In general, assuming a collaborative gripper with no sharp edges or other dangerous features, is attached to the robot, these robots can make horizontal motions at tip speeds up to 1.5 -2.0 m/sec, and bump into a person without causing a severe injury. For vertical motions, the Z speed should be limited to 150 mm/sec when the robot comes within 100 mm of a rigid surface, as the effective moving mass in Z is much greater than the effective moving mass in the horizontal plane. More detail is provided in the Collaborative Robot section of this manual.

A number of communications and hardware interfaces are provided with the basic robot. These include an RS-232 serial interface, an RS485 serial interface, an Ethernet interface, and a number of digital input and output lines. In addition, the robot can be purchased with several types of optional PreciseFlex peripherals. These include digital cameras, remote I/O, and a hardware manual control pendant.

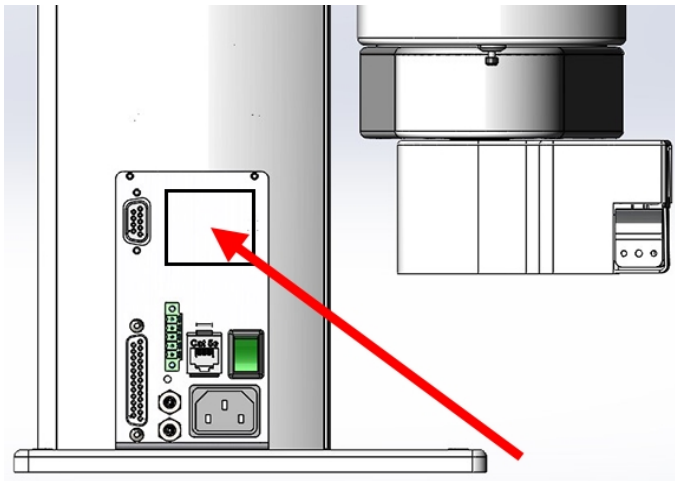
The controller is programmed by means of a PC connected through Ethernet. There are four programming modes: a Digital IO (PLC) mode, a Graphical User Programming Mode (Guidance Motion), an Embedded Language mode (GPL), and a PC Control mode (TCS). When programmed in the PLC, Graphical User Mode or Embedded Language mode, the PC can be removed after programming is completed and the controller will operate standalone. The PC is required for operation in the PC Control mode, which is implemented through a command-server interface.

In all modes of operation, the controller includes a web-based operator interface. This interface is used for configuring the system, starting and stopping execution, and monitoring its operation. The web interface can be accessed locally using a browser or remotely via the Internet. This remote interface is of great benefit in system maintenance and debugging.

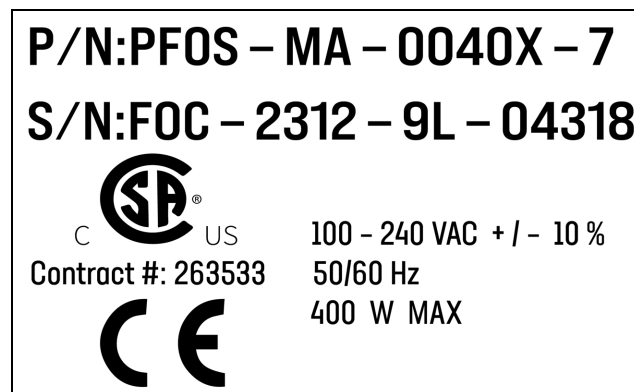
The optional machine vision system, PreciseVision, can execute either in a PC connected through Ethernet. PreciseVision requires cameras connected via Ethernet or USB, allowing any processor on the network to obtain and process information from any camera on the network, and provide the results to any networked motion controller.

## Explanation of the Product Label

The Product Label is on the robot interface panel at the base of the robot. Use the following sections to decode the Part Number and Serial Numbers .



Product Label at the Base of the Robot



Sample Robot Product Label



## Example Sections from the Product Label

**P/N:PFOS – MA – 0040X – 7**

In the example above, the first line of the label -- Product Number (P/N) -- describes these properties of its product.

- PFOS = PreciseFlex F400 (with Servo Gripper)
- MA = Machine Assembly
- 0040 = PreciseFlex 400
- X = Extended reach
- 7 = 750 mm Z Stroke
- <None> = Not Low Voltage

Refer to the [P/N - Part Number](#) table for detailed information about the Product Number naming scheme.

**S/N:FOC – 2312 – 9L – 04318**

In the example above, the second line of the label -- Serial Number (S/N) -- describes these properties of its product:

- FOC = PreciseFlex 400
- 23 = Two-Digit Year Code
- 12 = Two-Digit Month Code
- 9L = Revision
- 04318 = Robot Unit Build Number

Refer to the [Explanation of the Product Label](#) table for detailed information about the Serial Number naming scheme.



The symbol for the [CSA Group Standards Organization](#). See [Standards Compliance and Agency Certifications](#) for more information.

**Contract #: 263533**

Brooks Automation's Contract ID within the CSA Group



The [CE Marking](#) affirms compliance with relevant EU legislation. See [Standards Compliance and Agency Certifications](#) for more information.

<b>A</b>	<b>100 - 240 VAC + / - 10 %</b>
<b>B</b>	<b>50/60 Hz</b>
<b>C</b>	<b>400 W MAX</b>

**Robot Power Requirements**

Letter	Description
A	Robot power voltage requirements.

Letter	Description
B	Robot power frequency requirements
C	Robot power maximum draw

## P/N - Part Number

The robot part number follows the scheme: **AAAA-BB-CCCD-EFF**. Refer to the table below to decode this scheme.

AAAA	
CODE	PRODUCT
PP00	PrecisePlace 100
PP0S	PrecisePlace 100 (w/ Servo Gripper)
PF0S	PreciseFlex 400
PF30	PreciseFlex 3400
PFD0	Direct Drive Robot
PFC0	C-Series
PF0X	Linear Rail
BB	
CODE	TYPE
MA	Machine Assembly
CCCC	
CODE	TYPE
PF0S	0040 = PreciseFlex 400
PF30	0040 = PreciseFlex 3400
PFD0	0040 = Direct Drive 4 0060 = Direct Drive 6
D	
CODE	ARM LENGTH
0 / S	Standard
X / L	Extended / Long
E	
NUMBER	AXIS SIZE

4	400 mm Z Stroke
7	750 mm Z Stroke
12	1160 mm Z Stroke
10	1.0 m rail
15	1.5 m rail
20	2.0 m rail
<b>FF</b> (Optional)	
<b>CODE</b>	<b>Description</b>
LV	Low Voltage

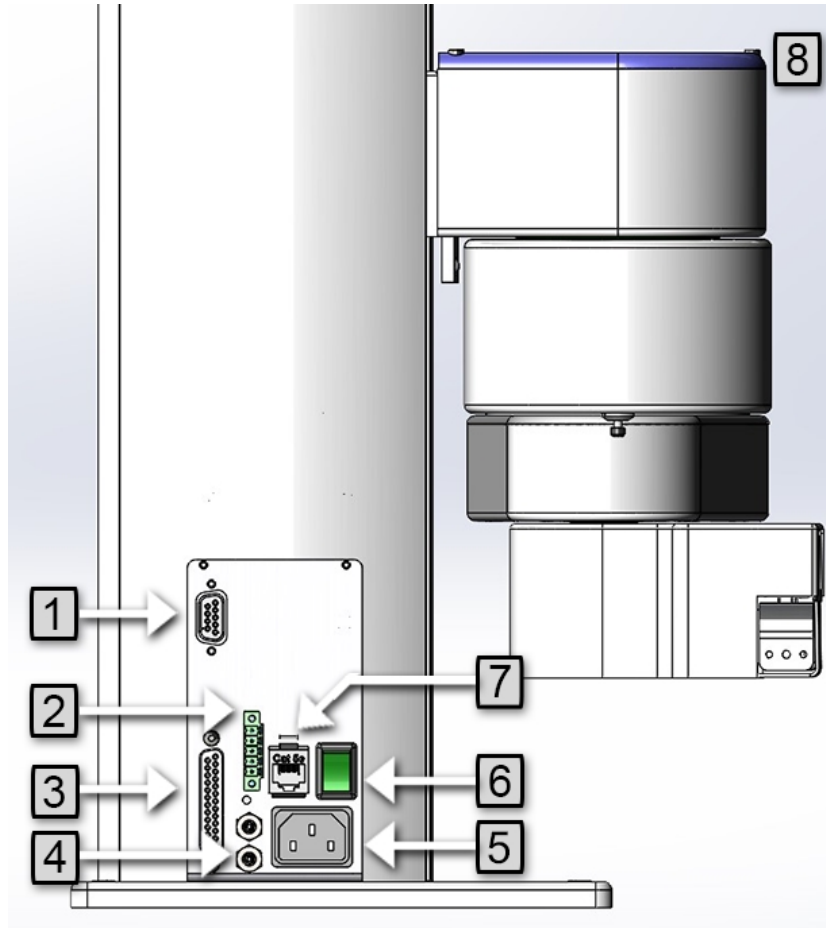
### Serial Number (SN)

The robot serial number follows the scheme: **AAA** - **BBCC** - **EF**-**GGGG**. Refer to the table below to decode this scheme.

<b>AAA</b>	
<b>CODE</b>	<b>MODEL</b>
P00	PrecisePlace 100
P0S	PrecisePlace 100 (w/ Servo Gripper)
F0C/F0X	PreciseFlex 400
F3C	PreciseFlex 3400
FC0	C-Series
FXB	Linear Rail
<b>BBCC</b>	
<b>CODE</b>	<b>MFG DATE CODE (START DATE)</b>
BB	Two-Digit Year Code
CC	Two-Digit Month Code
<b>EF</b>	
<b>Code</b>	<b>Rev Code</b>
E	Major Rev Code
F	Minor Rev Code Valid for Rev Code 9J and up
<b>GGGGG</b>	
G	Sequential Production Number

## Facilities Panel

The Facilities Panel is located at the base of the robot.



Facilities Panel key


Annotation	Name	Description
1	9 Pin2 D Sub Connector	Contains RS-232 Serial Port, 24 VDC, Ground can be used for optional teach pendant
2	E-stop Connector	E-stop and Cell Interlock Signals.
3	25 Pin D Sub Connector	For GIO module, 8 inputs, 8 outputs
4	Pneumatic Ports	For attaching air lines for optional pneumatic gripper. See the <i>PreciseFlex Servo Grippers</i> user manual.
5	Power Entry Module	For IEC plug. Contains dual fuse drawer.

Annotation	Name	Description
6	Power Switch	Lighted Power Switch
7	Ethernet Connector	For Ethernet to Computer Cable
8	Status Light	A blinking light indicates the normal state, a solid light indicates an error, and no light indicate a possible issue with the controller.


To simplify interfacing, most of the electrical interfaces provided by the robot's embedded Guidance Controller are available on the Facilities Panel. These include:

- [Digital input signals](#)
- [Digital output signals](#)
- [Ethernet port](#)
- [Remote Front Panel / MCP / E-Stop](#)
- [RS-232 serial interface](#)



Each of these interfaces is described in detail in the following sections. In addition, the robot's controller, which is mounted in the inner link of the robot, may contain additional interfaces (e.g. inputs or outputs). Refer to the *Guidance 1000A/B Controllers*, hardware introduction and reference manual for additional information.


DANGER  
High Voltage

The Guidance 1400B controller, and the 24 VDC and 48 VDC power supplies are all open frame electrical devices that contain unshielded high voltage pins, components and surfaces. The main AC power should always be disconnected before the Facilities Panel is removed.



If the pneumatic gripper option is ordered, two air lines are routed through the interior of the robot. At the Facilities Panel, these air lines are presented in a fitting on a sub plate mounted to the facilities panel. The other end of these lines exit at the Outer Link. When using these lines, clean, dry external air should be provided.

 <b>CAUTION</b> <b>High Pressure Air</b>	
<p>The maximum air pressure that can be conveyed by the air lines through the robot is 75 PSI. Applying a pressure exceeding this level may disconnect interior connections or damage fittings or hoses. If a higher pressure is required, an external air line should be utilized.</p>	

## PFDD Robots

The PFDD6 has a rated payload of 6 kg, including the gripper. The PFDD4 has a rated payload of 8 kg.

Note that for the PFDD robots, it is very important to set the correct value for the payload in the Dynamic Feed Forward parameter 16071 (or use the GPL “Robot.Payload” property). The payload can also be set using the operator Web Interface (see “Control Panels > Robot Payload”). This is very important prior to entering “Free Mode” as a drastically incorrect payload can cause the Z-axis gravity compensation to be incorrect and thus cause the Z-axis to start to move up or sag down, until the velocity restrict safety limit cuts in to stop any excessive speed. For the 6-axis robot, 100% equals 6 kg for the gripper and payload mass. For the 4-axis robot, 100% equals 8 kg for the gripper and payload mass. For lighter masses, this value should be reduced. Setting the payload correctly is important both for optimal dynamic performance of the robot and for proper gravity compensation, including “free” mode. For pick and place applications, the property “robot.payload” can be set by the application program to change the payload.

Also, it is important to set the correct tool X, Y, Z offset distance in mm in the first three values of parameter 16051 and tool Yaw, Pitch, and Roll in values 4-6, for the distance of the center of mass of the gripper and payload from the J6 axis of rotation. For example, for a horizontal tool, if the center of a 2 kg mass is 150 mm from the center of rotation of axis 4 (the wrist), this parameter should be set to 0, 0, 150, 0, 90, 0 for the Dynamic Feed Forward calculations to compute the correct feed forward motor torques and achieve optimal performance. For a vertical gripper with the same offset, this parameter should be 0, 0, 150, 0, 0, 0. The tool offset length must also be set in the Dynamic Feed Forward parameter 16068 value 8 for the PFDD6 and value 6 for the PFDD4. The tool mass, in kg, must be set in parameter 16067 value 8 for the PFDD6 and value 6 for the PFDD4, in order for the Dynamic Feed Forward to work properly.

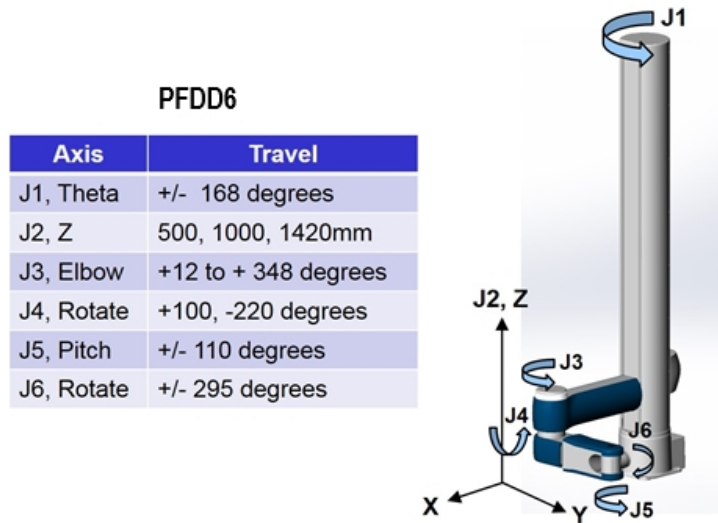
Note that when setting the payload and gripper payload offset parameters in the database, these values must be entered, saved to flash, and the controller must be re-booted for them to take effect. See the software documentation about Parameters 16051, 16071, 16067, 16068, and the “Robot.Tool” and “Robot.Payload” properties for more a more detailed explanation.

These robots have twelve inputs and eight outputs available at the base connector panel in a 25-pin D-subminiature connector and have two digital outputs and up to three digital inputs available in the outer link when the pneumatic version is ordered. A belt encoder input is available on the connector panel. These robots are nominally quoted and shipped with a standard ISO flange, and a single solenoid valve mounted in the outer link for users to add pneumatic or vacuum grippers of their

design. Optionally, an additional solenoid can be ordered, or a 23 N squeeze, 60 mm travel electric gripper can be ordered. See "System Dimensions" on page 49 for reference dimensions on these options.

## System Diagram and Coordinate Systems

The major elements of the PFDD Direct Drive robots and the orientation and origin of their World Cartesian coordinate systems are shown in Figure 3-1 and Figure 3-2.



**Figure 3-1: PFDD Six-Axis Direct Drive Robot**

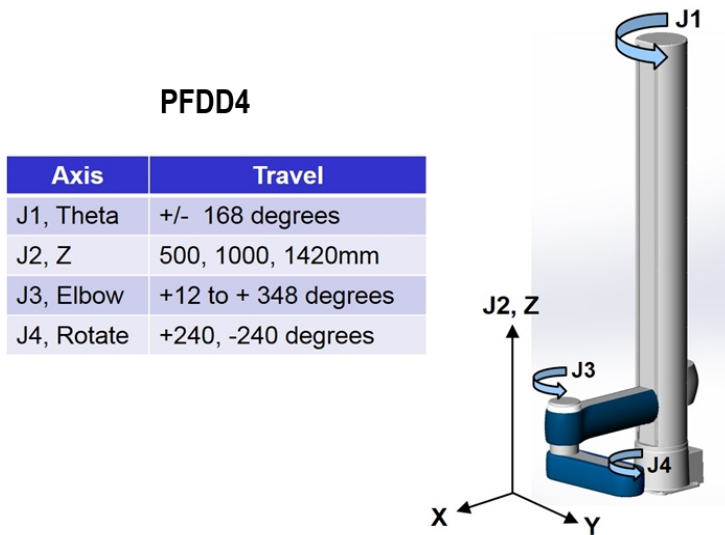
The first axis of the robot, J1, rotates the robot column about the Z-axis. When inner link is closest to the bottom, the Z-axis is at its 0 position in the Joint Coordinate system and in the World Coordinate system. As the robot arm moves upwards, both its joint position and the World Z Coordinate increase in value.

The Z column also contains the 24VDC and 48VDC power supplies. The main PreciseFlex™ controller is located inside the base housing of the robot, and joint controllers are located near the various joint motors, distributed throughout the robot. When the Inner Link is centered on its range of motion the J1 axis is at its 0-degree joint angle. A positive change in the axis angle results in a positive rotation about the World Z-axis.

The J3 rotary axis (elbow) rotates the outer link about the J3 axis. A positive change in the axis angle results in a positive rotation about the J3-axis. When the link is centered, it is at its 0-degree joint angle, however there is a hard stop at 10 degrees, so the link cannot reach the center position. The outer link can rotate underneath the inner link, allowing the robot to change configuration from a "left hand" robot to a "right hand" robot without swinging the J3 axis (elbow) through the zero position. This allows the robot to work in very compact workcells, and minimizes the radius to the payload, and therefore the kinetic energy of the payload, when moving across a workcell. This helps minimize potential collision forces.



The J4 rotary axis rotates the outer link about its axis. Its travel is asymmetric to allow J5 to be oriented +/- 180 degrees without hitting a J4 hard stop. The J5 pitch axis provides pitch control for the tool. The J6 rotary axis rotates the tool about the tool axis.



**Figure 3-2: PFDD Four-Axis Direct Drive Robot**

For the PFDD4, the J4 axis is at the end of the outer link and is parallel to the J1 axis. A positive change in the J4 axis angle results in a positive rotation about the World Z-axis.

The outer link may include a gripper controller that provides control of the optional electric gripper. It is also possible to order the robot with a pneumatic gripper; in which case the outer link will house a solenoid to control air to the pneumatic gripper. A light bar is mounted at the top of the elbow and blinks once per second to indicate that the controller is operational and blinks four times per second when power is being supplied to the motors.

The Z-axis includes a fail-safe brake. This brake must be released to move the Z-axis up and down manually. There is a manual brake release button on the bottom of the inner link near the Z-axis. Depressing this button when 24VDC power is on will release the Z-axis brake while the button is depressed. It is not necessary for the control system to be operating for the brake release to function; the only requirement is providing 24VDC to the controller. Care should be taken to support the Z-axis when the brake release button is pushed, as the axis will fall due to gravity.

## Control System Overview

The PFDD Robots are controlled by a distributed control system (see Figure 3-3). The main control board (PFDD0) is located in the base casting behind the connector panel. This board contains various IO functions, the main CPU, RAM and Flash memory, and the motor drive for the J1 motor. The 24VDC and 48VDC power supplies are located on the back of the Z column. A flexible ribbon cable is routed around the robot to provide 24VDC, Gnd, 48VDC, Gnd, Ethernet, and RS485. Ethernet is routed to the outer link and is available for certain gripper applications. A series of smart amplifiers (GSBP) are distributed around the robot and located near each motor to minimize wiring through the robot. These are connected by means of an RS485 network.

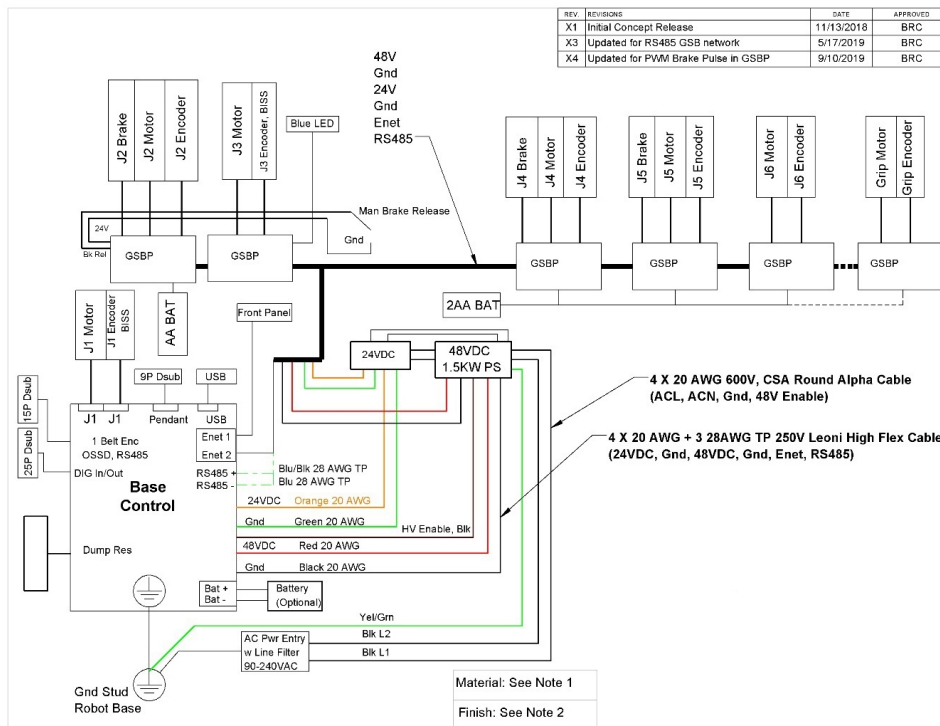




Figure 3-3: Distributed Control System

## Power Supplies and Power Considerations

The PFDD controllers require two DC power supplies, a 24VDC power supply for the processor and user IO, and a separate 48VDC motor power supply.

 <b>DANGER</b> Electrical Shock	
<p>The 24VDC power supply is an open frame electrical device that contains unshielded high voltage pins, components and surfaces. These products are intended to be mounted in a cabinet or machine chassis that is not accessible when AC line power is turned on.</p>	

The PFDD robots power supplies have an input range of 100 to 240 VAC, +/- 10%, 50/60 Hz. Inrush current can be as high as 40 Amps at 240 VAC for short periods of time. The power supplies are protected against voltage surge to 2000 Volts. Transient over voltage (< 50  $\mu$ s) may not exceed 2000 V phase to ground, as per EN61800-31996. The power supplies have over-current protection, and over-voltage protection.

The robot consumes less than 500 Watts during normal operation. With the motor power turned off the controller consumes about 20 Watts. With the motor power on and the Z brake released, the robot consumes about 80 Watts. The PFDD6 running at 60% speed consumes about 150 Watts. These numbers may be useful when mounting this robot on mobile platforms.

The PreciseFlex controller can monitor motor power through its datalogging function. Intermittent power dropouts can be detected by setting a trigger in the data logger which can record and time-stamp power fluctuations.

## Energy Dump Circuit

The 48VDC supply has a regulated output and an overvoltage protection circuit that is triggered if the voltage reaches 60 Volts. Rapid deceleration of the robot motors can generate a Back EMF voltage that can pump up the motor voltage bus. In order to avoid bus pump up, an Energy Dump Circuit is included in the base controller board and connected to the 48VDC bus.

## Remote Front Panel, E-Stop Box and Manual Control Pendant

Brooks offers an E-Stop Box or a portable Hardware Manual Control Pendant (product number PP10-EP-00013) that includes an E-Stop button. The E-Stop box can be plugged into the 9 pin D-Sub connector in the connector panel in the base casting. The E-Stop box completes a circuit from Pin 1 (Estop 1) to Pin 6 (FE Out 1) and from Pin 2 (Estop 2) to Pin 7 (FE Out2) in this connector. If this circuit is not completed, it is not possible to enable motor power to the robot. The FE Out signals allow each Estop circuit to be toggled during the CAT3 startup sequence to make sure both circuits are working. If no E-Stop box or Manual Control Pendant is connected, jumpers must be connected between these four pins to enable robot motor power. For those applications where an operator must be inside the working volume of the robot while teaching, a second teach pendant with a 3-position run hold switch is available. The Manual Control Pendants can be plugged directly into the 9 pin Dsub connector mounted on the robot's Facilities Panel in the base of the robot.



Figure 3-4: E-Stop Button



Figure 3-5: Manual Control Pendant

## Remote IO Module (Ethernet Version)

For applications that require a large number of Inputs and Outputs, a Precise Remote IO (RIO) module may be purchased. The RIO interfaces to any PFDD robot and its embedded PreciseFlex™ Controller via 10/100 Mb Ethernet and requires 24VDC power. Up to four RIOs can be connected to a controller.

The basic RIO includes:

- 32 isolated digital input signals
- 32 isolated digital output signals
- One RS-232 serial line

An enhanced version of the RIO adds 4 analog input signals, a second RS232 port, and one RS-422/485 serial port.

The Enhanced RIO module is pictured in [Figure 3-6](#).



**Figure 3-6: Enhanced RIO Module**

## Machine Vision Software and Cameras

The PreciseFlex Controllers support the PreciseVision machine vision system. This is a vision software package that can run in a PC.

Cameras must be connected via Ethernet or USB. Vendors such as DALSA already offer a variety of Ethernet machine vision cameras. In addition, other vendors offer USB cameras that are supported in PreciseVision.

PreciseFlex offers an Arm-Mounted Camera Option for certain robots. For details, email [support\\_preciseflex@brooksautomation.com](mailto:support_preciseflex@brooksautomation.com) for details.

## Machine Safety

### Safety and Agency Certifications

PreciseFlex systems can include computer-controlled mechanisms that are capable of moving at high speeds and exerting considerable force. Like all robot and motion systems, and most industrial equipment, they must be treated with respect by the user and the operator.

This manual should be read by all personnel who operate or maintain PreciseFlex systems, or who work within or near the work cell.

For more information, read ENISO 10218-1:2011 and 10218-2:2011 Robots for Industrial Environments, Safety Requirements, ISO/TS 15066 *Robots and Robotic Devices – Collaborative Robots* and ISO 13849-1:2006 *Safety of machinery — Safety-related parts of control systems*.

## Standards Compliance and Agency Certifications

The PFDD robots are intended for use with other equipment and are considered a subassembly rather than a complete piece of equipment on their own. They meet the requirements of these standards:

- ISO/TS 15066 / RIA TR R15.806
- EN ISO 10218-1-2011 Robots for Industrial Environments, Safety Requirements
- EN 60204-1 Safety of Machinery, Electrical Equipment of Machines
- EN 61000-6-2 EMC Directive (Immunity)
- EN 61000-6-4 EMC Directive (Emissions)

To maintain compliance with the above standards the robot must be installed and used in accordance with the regulations of the standards, and in accordance with the instructions in this user's guide.

In addition to the above standards, the PF400 and PF3400 robots have been designed to comply with the following agency certification requirements, and will carry the CE and CSA marks.

- CE
- CSA
- FCC Class A
- ANSI/RIA R15.06 Safety Standard

## Moving Machine Safety

The PFDD robots can operate in Manual Control Mode, in which an operator directly controls the motion of the robot, or Computer Control Mode in which the robot operation is automatic. Manual Control Mode is often used to teach locations in the robot workspace. The robot's speed is limited in Manual Control Mode to a maximum of 250 mm per second for safety. It is important that operators wear safety glasses when inside the robot's operating volume.

In Computer Mode, the robot can move quickly. The PFDD robots have been designed to be "hand-safe" even in computer mode, and in some cases a risk assessment of the application may indicate that it can be used without operator safety screens. However, safety glasses should be worn at all times when an operator is within the robots working volume. Refer to the EN ISO 10218-2-2011 Robots for Industrial Environments, Safety Requirements for information on recommended safe operating practices and enclosure design for robots of various sizes and payloads.

## Mechanical and Software Limit Stops

All joints have hard limit stops at the end of travel which are factory installed. The soft-limit stops must be set within the range of these hard stops. The wrist axis in the PFDD4 has a slip ring when the electric gripper is installed, allowing +/- 240 degrees rotation. Since the robot has absolute encoders with battery backup, even if the robot is turned off, the encoders keep track of joint

position. The joint position can be viewed either on the optional Manual Control Pendant, or in the Virtual Manual Control Pendant in the Web Based Operator Interface. See the *Guidance Controller Setup and Operation Quick Start Guide* for more information.

## Stopping Time and Distance

The robot control system responds to two types of E-Stops.

### Soft E-Stop

A Soft E-Stop initiates a rapid deceleration of all robots currently in motion and generates an error condition for all GPL programs that are attached to a robot. This property can be used to quickly halt all robot motions in a controlled fashion when an error is detected. A soft E-Stop is typically generated by an application program under conditions determined by the programmer.

This function is similar to a hard E-Stop except that soft E-Stop leaves High Power enabled to the amplifiers and is therefore used for less severe error conditions. Leaving power enabled is beneficial in that it prevents the robot axes from sagging and does not require high power to be manually re-enabled before program execution and robot motions are resumed. This function is also similar to a Rapid Deceleration feature except that a Rapid Deceleration only affects a single robot and no program error is generated.

If set, the **SoftEStop** property is automatically cleared by the system if High Power is disabled and re-enabled.

### Hard E-Stop

A Hard E-Stop is generated by one of several hardware E-Stop inputs and causes motor power to be disabled. However, there is a parameter that determines a delay between the time the hard E-Stop signal is asserted and the time the motor power supply relay is opened. This delay is nominally set at 1.0 seconds. It may be adjusted by an operator with administrator privileges. On the web-based operator interface menu, go to Setup/Parameter Database/Controller/Operating Mode/ and set parameter 267 to the desired delay. If this delay is set to 0, the motor power will be disabled within 1 ms.

For the PFDD6 robot, the base rotation, elbow, and J6 axes do not have mechanical brakes. For the PFDD4 robot, the base rotation, elbow, and J4 axes do not have mechanical brakes. Therefore, leaving the motor power enabled for 1.0 sec allows the servos to decelerate the robot. The servos are set to decelerate the robot at 0.015 G, or 150 mm/sec<sup>2</sup>. If the robot is moving at a joint speed of 100 degrees/sec, the distance traveled will be about 30° to reach a full stop, and the time will be 0.66 sec. These settings provide a smooth deceleration and stop with full payload. If a faster deceleration is desired, contact Precise Collaborative Robotics application engineering to increase the deceleration setting for E-Stop.

## Safety Zones

For all robot types, “Safety Zones” can be defined that disable motor power and halt the motion of the robot if its tool center point (TCP) violates the requirements of a user defined 3D volume.

---

**NOTE:** Safety zones are implemented in software only.

---

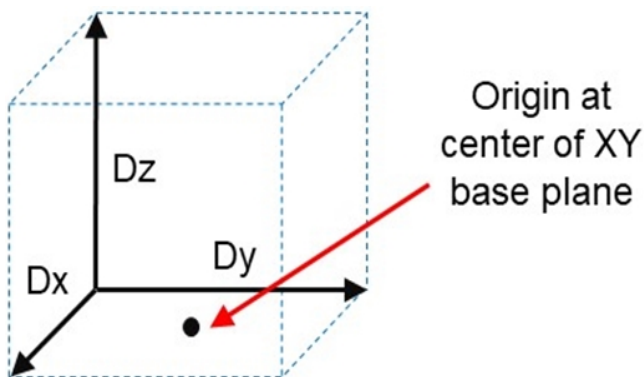
### Types of Safety Zones

These 3D safety zones can be used to:

1. Approximately model the volume of stationary objects or personnel working areas to prevent the robot from inadvertently entering this volume and causing a collision (“keep out zones”).
2. Reduce the normal working volume of the robot to prevent the robot from reaching beyond prescribed boundaries and causing a collision (“stay within zones”).
3. Verify that the robot’s TCP speed (when in a specified volume) is below a specified limit so that the robot can be safely decelerated and stopped before it might pin an operator’s hand to a hard surface with too high a force (“speed restrict zones”).

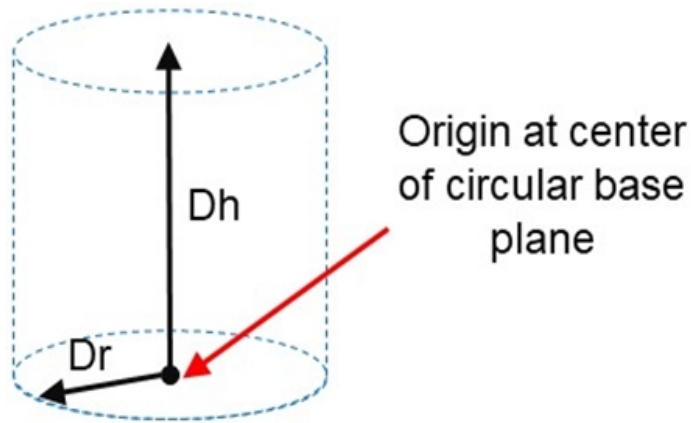
As currently implemented, the “keep out zones” and “stay within zones” are provided as general safety features, but they do not meet the stringent Category 3 safety standards that require fail safe redundant logic. However, the “speed restrict zones” do provide the requisite redundancy and are in the process of being Category 3 certified. The “keep out zones” and “stay within zones” are collectively referred to as “uncertified zones” and the “speed restrict zones” are referred to as “certified zones”.

The supported zone shapes are rectangular volumes, cylinders and spheres. To define a safety zone, the type of safety zone must be specified along with its origin and dimensions.

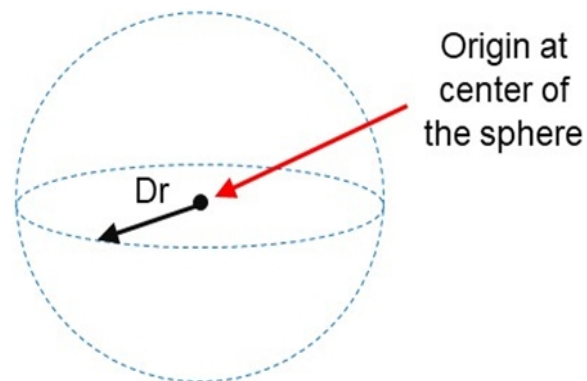


**Figure 3-7: Rectangular Volume**





**Figure 3-8: Cylinder**



**Figure 3-9: Sphere**

For increased generality, uncertified zones can be arbitrarily positioned and rotated in all three dimensions. Due to implementation limitations, certified zones must be non-rotated rectangular volumes, which can be arbitrarily positioned. Up to 10 zones can be defined for each robot and any mix of certified and uncertified can be specified. Due to safety requirements, any new or modified zone specifications only go into effect after the controller is rebooted.

### Safety Zone Violation Detection and Clearing

Uncertified safety zones are active in the following circumstances:

- Continuously during program-controlled motions of all types (straight line or arc Cartesian and joint interpolated).
- Continuously during manual (jog) control modes: World, Tool and Joint, but not free.

- Motion planning (final destinations only).
- Location object.KineSol method during conversions to either Cartesian or joint Locations.

Certified safety zones are only active during program-controlled motions (of all types) since this is the only circumstance where higher TCP speeds are possible.

When motor power is enabled and the robot's TCP is in violation of an uncertified safety zone, a program-controlled motion cannot be initiated. This condition can be cleared by disabling motor power and manually repositioning the robot or by manually jogging the TCP in World, Tool or Joint modes, so long as the jog motion reduces the safety zone violation distance. That is, jogging motions that increase the violation of a safety zone are not permitted.

---

**NOTE:** Safety zone testing is based on the TCP of the robot. Therefore, it is very important that the position of the tool center point relative to the robot's tool mounting flange is set correctly. Please see the Robot.Tool property for information on defining the TCP.

---

## Certified Speed Restrict Safety Zones

While the uncertified safety zones perform conventional tests on just the position of the TCP, there are two certified safety zones and these perform special tests to detect if the speed of the TCP exceeds a limit while the TCP is within the zone. The first certified safety zone tests if the Z downward speed of the TCP exceeds a specified limit. This safety zone was implemented for the PreciseFlex 400 and PreciseFlex 3400 robots since their only intrinsically non-safe motion is a high-speed downward Z motion that could trap a person's hand between the tooltip and a fixed object or horizontal surface. The second certified safety zone tests if the horizontal, XY planar, speed of the TCP exceeds a specified limit. This test was developed for the PreciseFlex™ DD robots since robots can generate excessive speeds when moving horizontally.

For both of these tests, in order to satisfy the computational redundancy requirement of the Category 3 safety regulations, the shapes of these safety zones are limited to non-rotated rectangular volumes.

Please consult the user manuals for these PreciseFlex™ robots for when speed restrict safety zones must be defined to safely operate these mechanisms.

## Configuring Safe Zones

Up to 10 safety zones can be defined per robot. Each of these zones is specified by filling in one of the Parameter Database IDs 16900 to 16909, which are labeled "Safety Zone: type, x/y/z/y/p/r, dim 1/2/3". Any combination of certified and uncertified safety zones can be specified. Each of these DataIDs consists of an array of 10 numbers and the first value defines the safety zone "type". Any DataID that has a zero "type" is ignored. [Table 3-1](#) describes the possible safety zone types:

**Table 3-1: Safety Zone Types**

Safety Zone Type	Description
0.	Undefined safety zone
1.	Rectangular volume, keep out zone
2.	Cylinder, keep out zone
3.	Sphere, keep out zone
4.	Rectangular volume, stay within zone
5.	Cylinder, stay within zone
6.	Sphere, stay within zone
7.	Non-rotated rectangular volume, Z downward speed restrict zone
8.	Non-rotated rectangular volume, XY speed restrict zone

[Table 3-2](#) describes the safety zone DataIDs. When any of these DataIDs are modified, the controller must be rebooted for the change to be put in effect.

**Table 3-2: Data IDs**

DataID	Parameter Name	Description
16900 to 16909	Safety Zone: type, x/y/z/y/p/r, dim 1/2/3	<p>Each safety zone definition consists of an array of 10 values. The first value is the safety zone “type”. The next six values define the position of the origin of the volume of interest and its orientation. This is specified as a standard Location value:</p> <p style="text-align: center;">x, y, z, yaw, pitch, roll.</p> <p>The final three values define the size of the volume of interest. For the permitted shapes, this is interpreted as:</p> <p style="text-align: center;">volume: Dx, Dy, Dz Cylinder: Dh, Dr, 0 Sphere: Dr, 0, 0</p> <p>For example, for a downward Z non-rotated rectangular volume speed restrict safety zone, a single DataID should be specified as follows:</p> <p style="text-align: center;">7, x, y, z, 0, 0, 0, Dx, Dy, Dz</p> <p>Where x, y, z are the coordinates of the center of the base of the rectangular volume and Dx, Dy, Dz are the dimensions of the volume, all in mm.</p>

In addition, the DataID in [Table 3-3](#) must be initialized to establish the maximum speed limits for the certified safety zones:

**Table 3-3: Data IDs**

DataID	Parameter Name	Description
2740	Certified safety zone, max Z/XY spd mm/sec	<p>These parameters define the maximum speeds that are permitted for the Certified Speed Restrict Safety Zones. The first value is the maximum downward Z speed (when within the safety zone) in mm/sec. Since this is a downward speed, it should be a negative value and defaults to -200. The second value is the maximum permitted speed in the horizontal XY plane (when within the safety zone), and defaults to 200 mm/sec.</p>

## Releasing a Trapped Operator: Brake Release Switch

Should a hard E-Stop be triggered, the Z brake will engage, and motor power will be disconnected from all motors. As the J1, J3, and J6 axes on the PFDD6, and the J1, J3, and J4 axes on the PFDD4 do not have brakes, they may be freely pushed by the operator. To release the Z brake, the operator may press the brake release switch under the inner link as long as 24 VDC is present. It is not necessary for motor power to be on for the brake release to work.

---

**NOTE:** The J4 and J5 brakes on the PFDD6 are not released by the brake release switch to prevent unexpected sagging of the payload.

---



**Brake Release Switch**

## 3. Installation Information

### Environmental Specifications

The PFDD robots must be installed in a non-condensing environment. Tape seals for the vertical column are an optional order item for environments where fluid or particles may splash against the robot. For applications where the connector panel in the base may be exposed to conductive particles or fluid, it is recommended a panel cover splash hood be added to protect the connectors. With tape seals and a connector hood the robot is rated at IP52. Without these features the robot is rated at IP11. This robot is not intended for use in a washdown or heavy spray environment. See the [Environmental Specifications](#) in Appendix B for specific environmental limits.

### Setup and Operation

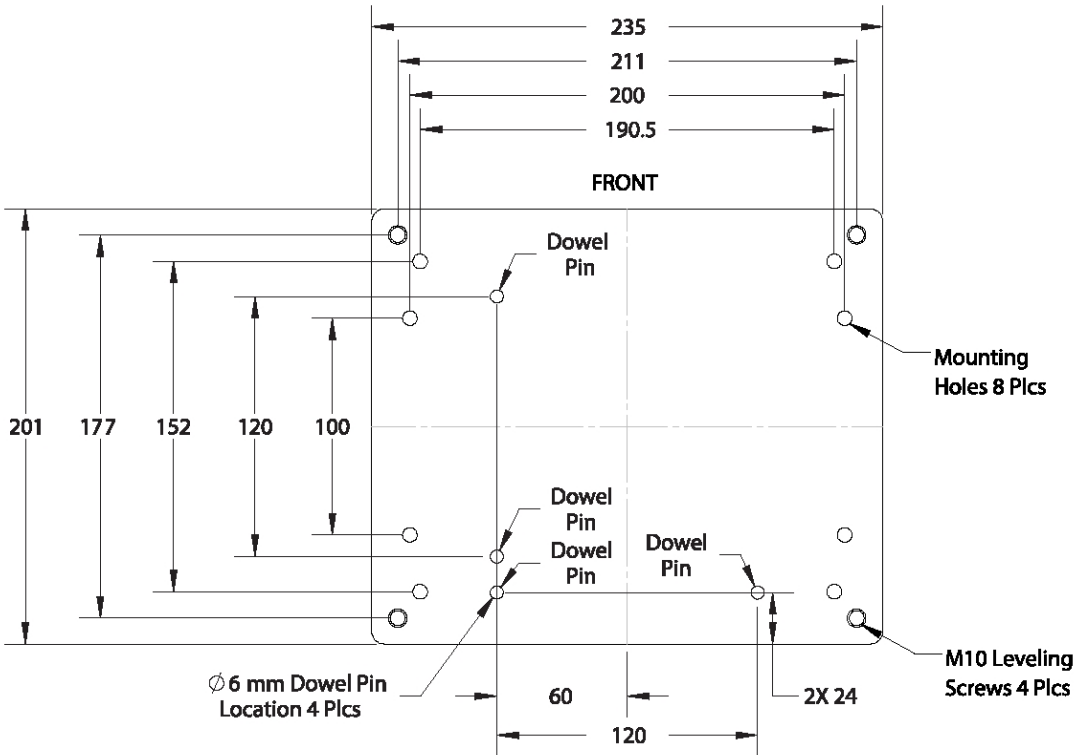
1. Unpack the PreciseFlex robot.
2. Mount the robot.
3. Add or remove a gripper (optional). See the *PreciseFlex Gripper* user manual.
4. Connect the power.
5. Connect the PreciseFlex robot to a PC or tablet, and open the interface.
6. Run the robot. See [Accessing the Web Server](#).

### Unpacking and Handling Instructions

PreciseFlex robots are shipped in wooden crates with international ratings and foam inserts to protect the robots. As the robots weigh 25 kg or more, two persons should move the robot to the installation location.

### Mounting Instructions

PreciseFlex robots must be attached to a rigid surface that can withstand lateral forces of 200 Newtons without moving or vibrating. The robot base has an integrated bolting pattern to accommodate (4) M6 socket head cap screw (SHCS) mounting screws located as shown below.



## Tool Mounting

The PreciseFlex robots are typically supplied with an electric gripper. In some cases, a pneumatic gripper may be supplied by Brooks or by the end user. However, the standard robot does not include pneumatic lines, so if pneumatic tooling is needed, the robot must be ordered with pneumatic lines installed. The outer link has a flange for users to attach grippers or tooling.

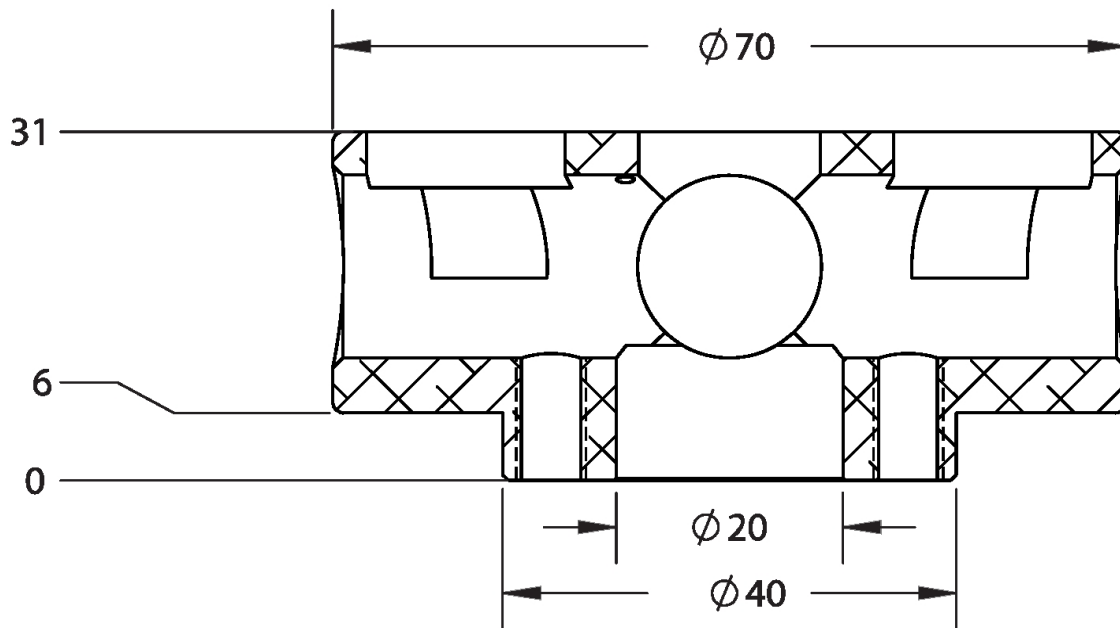
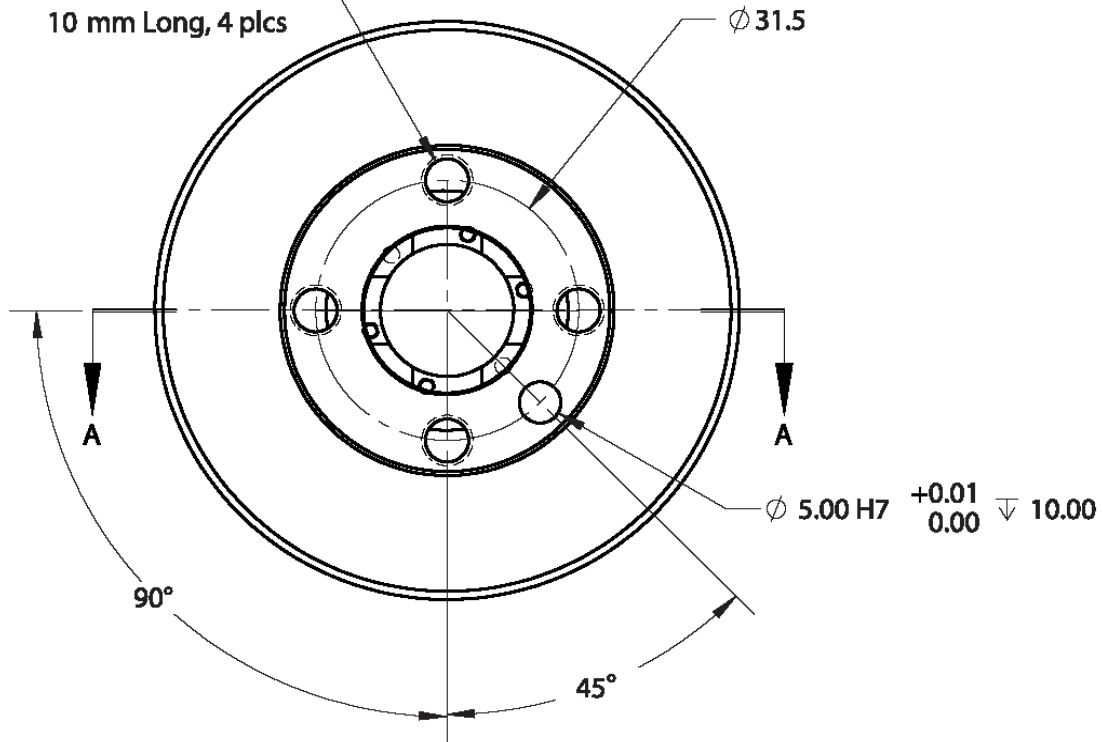
To facilitate electrical interfacing to user tooling, digital I/O signals are available in the outer link. For robots with an electric gripper, the electric gripper controller in the outer link has two extra inputs and two extra outputs available for users. However, it should be noted that all the wires in the 18 conductor slip ring are consumed by the electric gripper, so any additional IO wiring will have to be routed outside the robot wrist. For robots without the electric gripper, a ribbon cable from the G1400A controller is routed to the outer link. This ribbon cable provides four digital inputs and four digital outputs from the controller.

For robots where support for a pneumatic gripper or pneumatic tooling has been ordered, one or two 1/8 in OD air hoses are routed from the connector plate in the base through the robot and out to the outer link. These air hoses can be connected to one or two solenoids mounted in the outer link for tooling control.

## ISO Flange for End-of-Arm Tooling

ISO-9409-1-31.5-4-M5

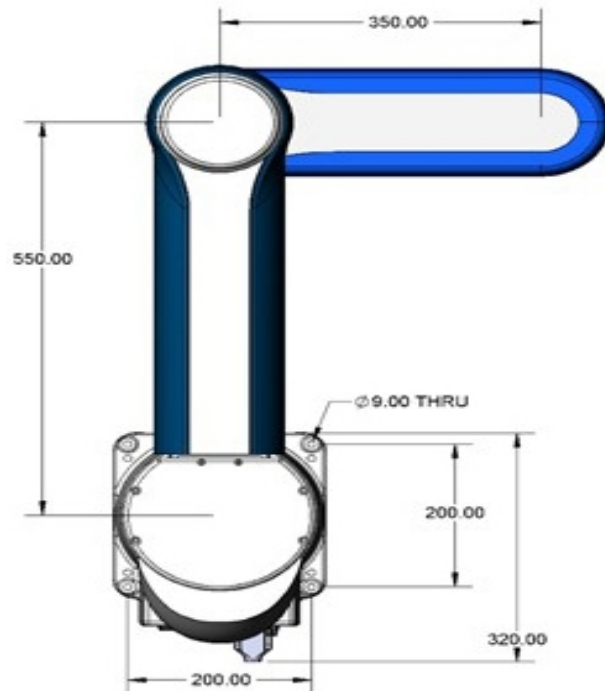
M5 Helicoil Insert  
10 mm Long, 4 plcs



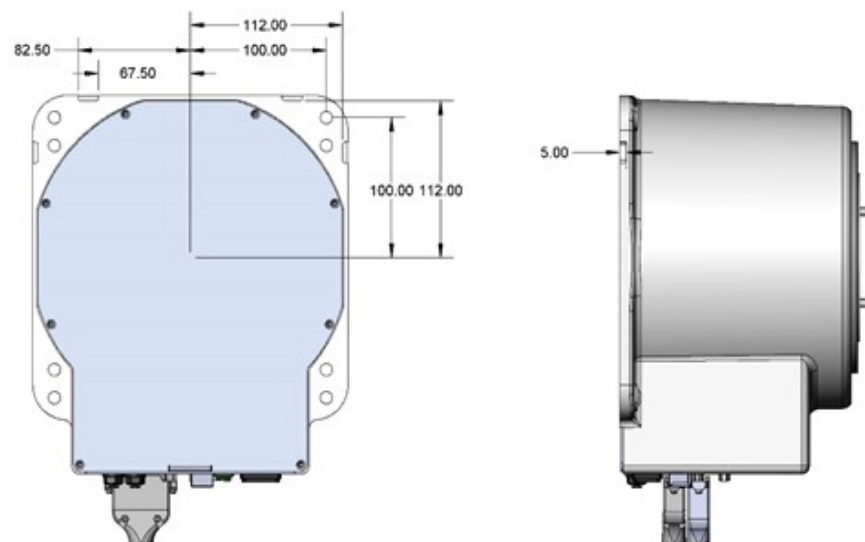


## System Dimensions

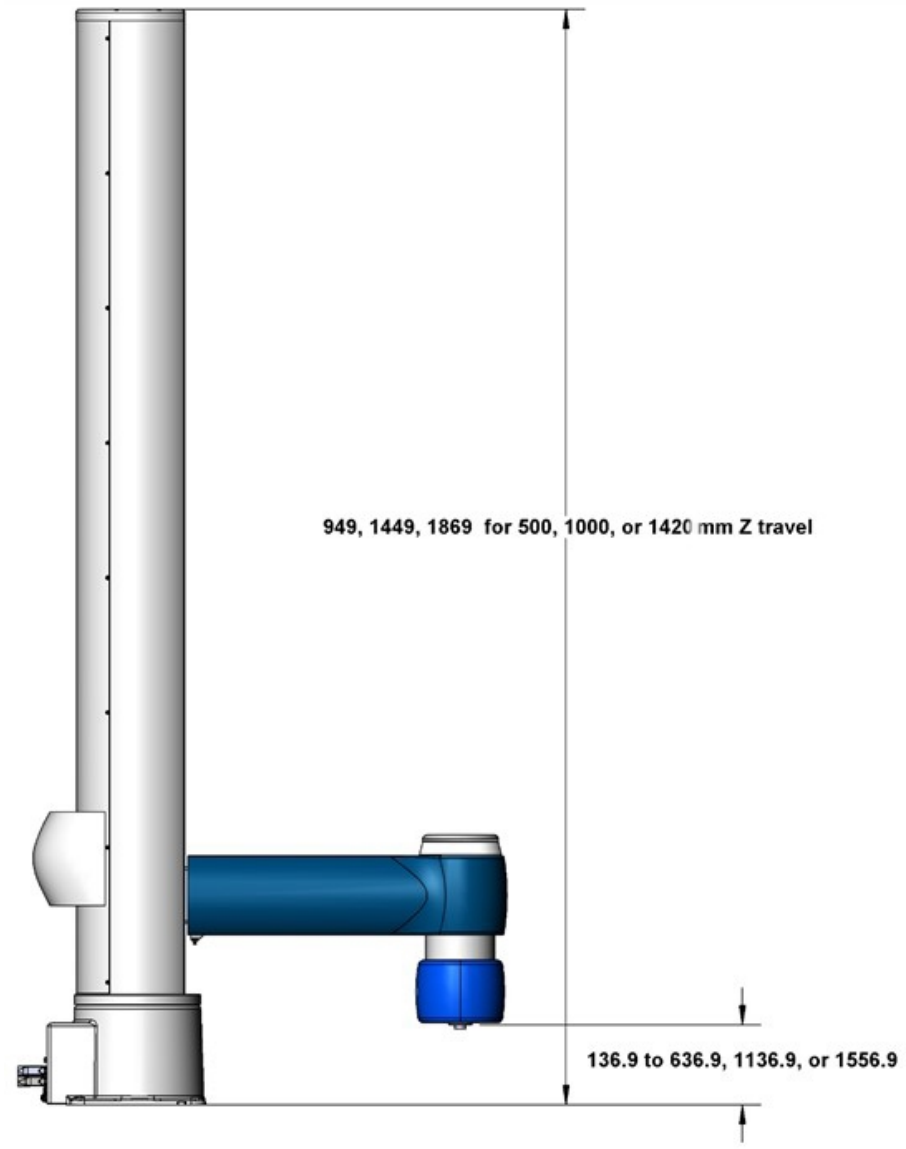
All dimensions are in millimeters.



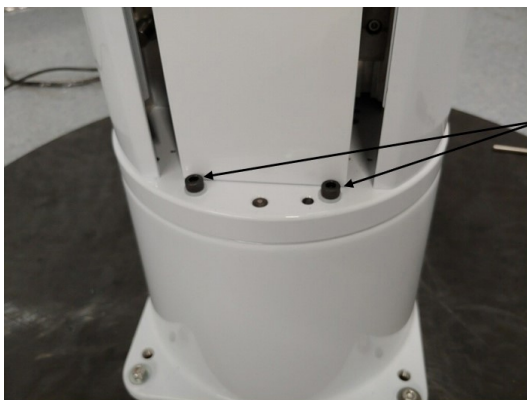
### Mounting Dimensions for PFDD Robots



### Base Alignment Notches



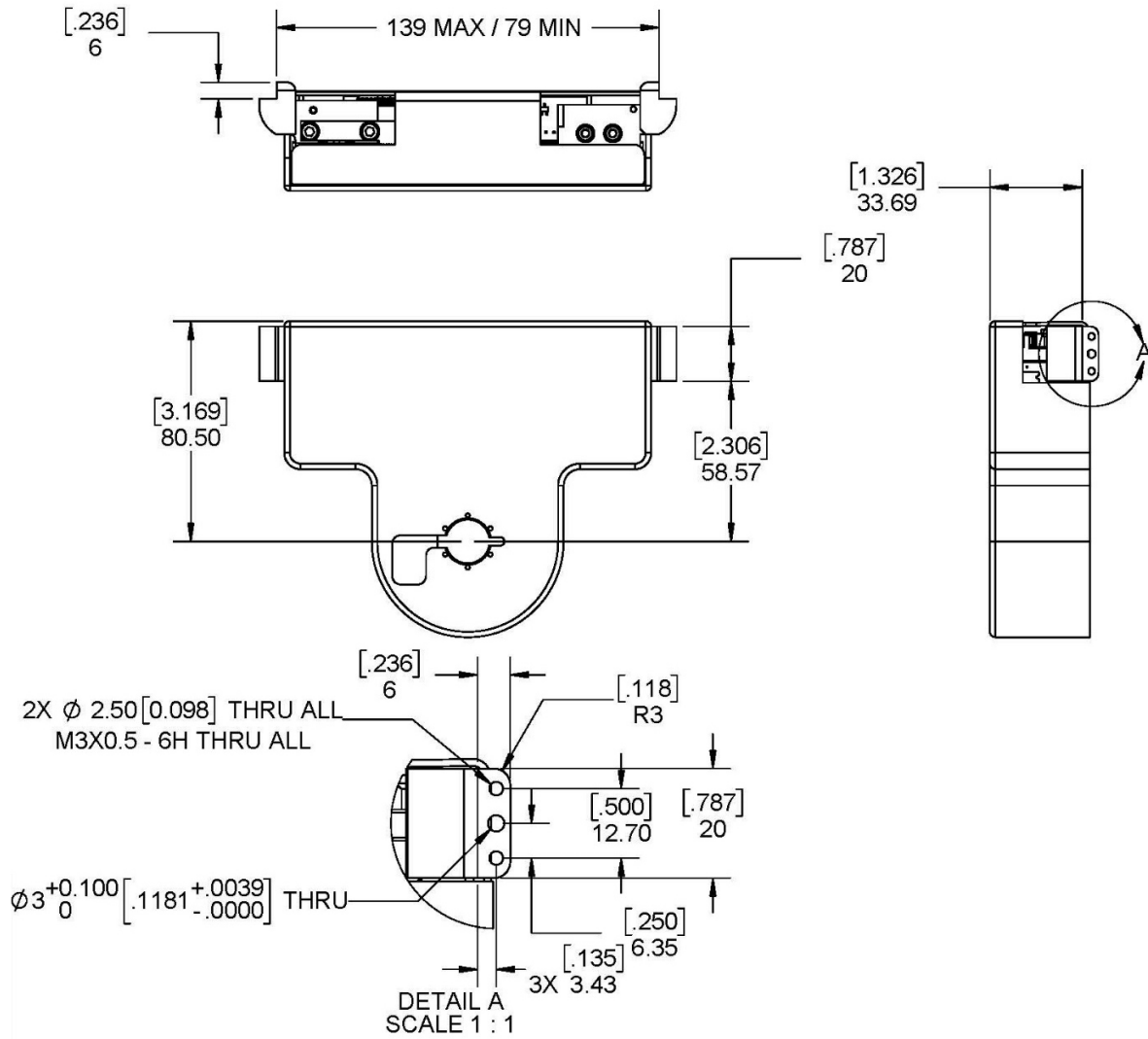
### Gripper Flange Mount Height PFDD4



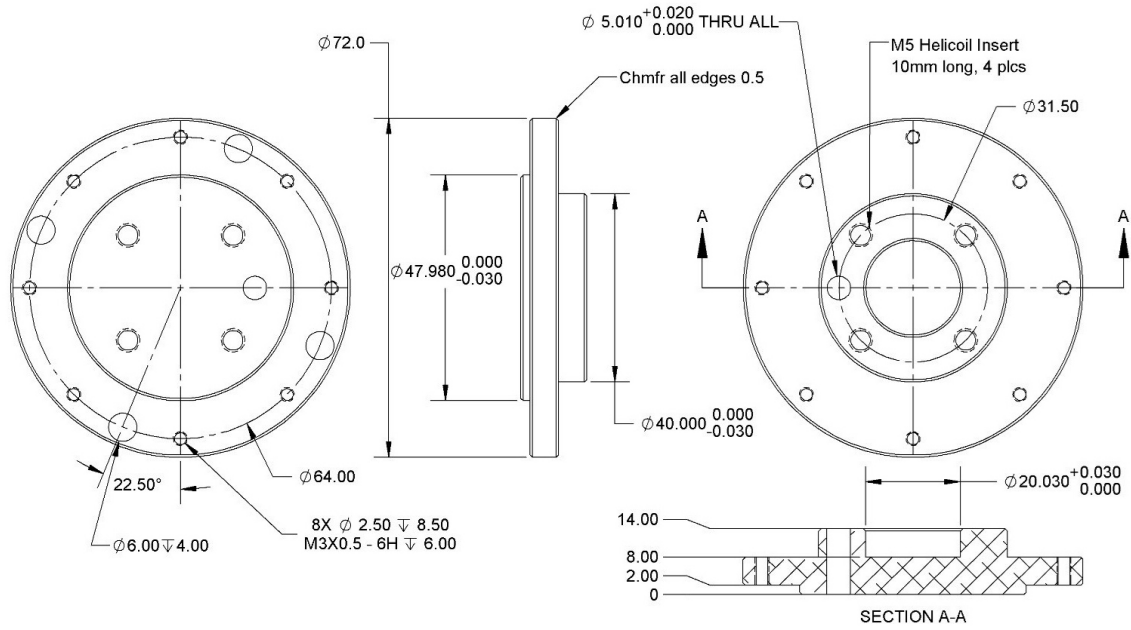
These bolts restrain rotation of base with arm straight out.  
 Use two M6-50 SHCS (McMaster-Carr 91290A205) and two M6 Nylon Washers (McMaster-Carr 95610A570 ). Torque to hand tight.

Make sure these bolts are removed prior to operating robot after robot is bolted in place. These should be installed before any lifting of the robot occurs.

### Gripper Flange Mount Height PFDD6

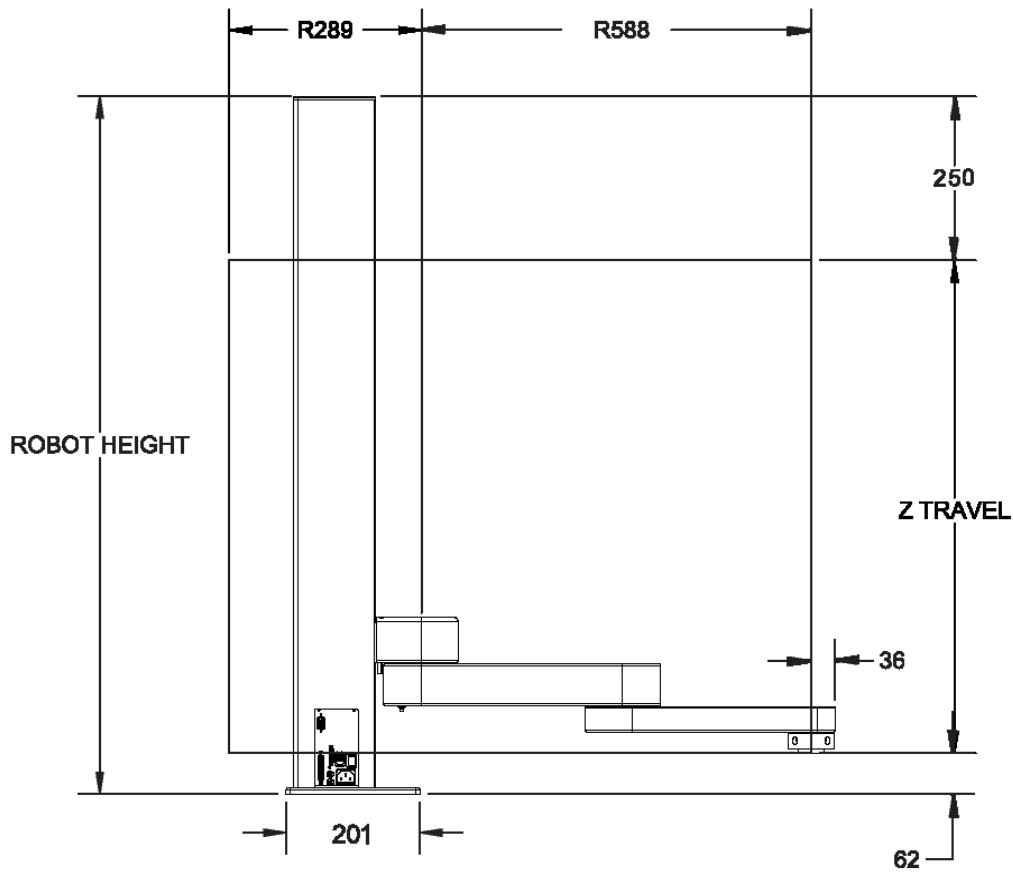


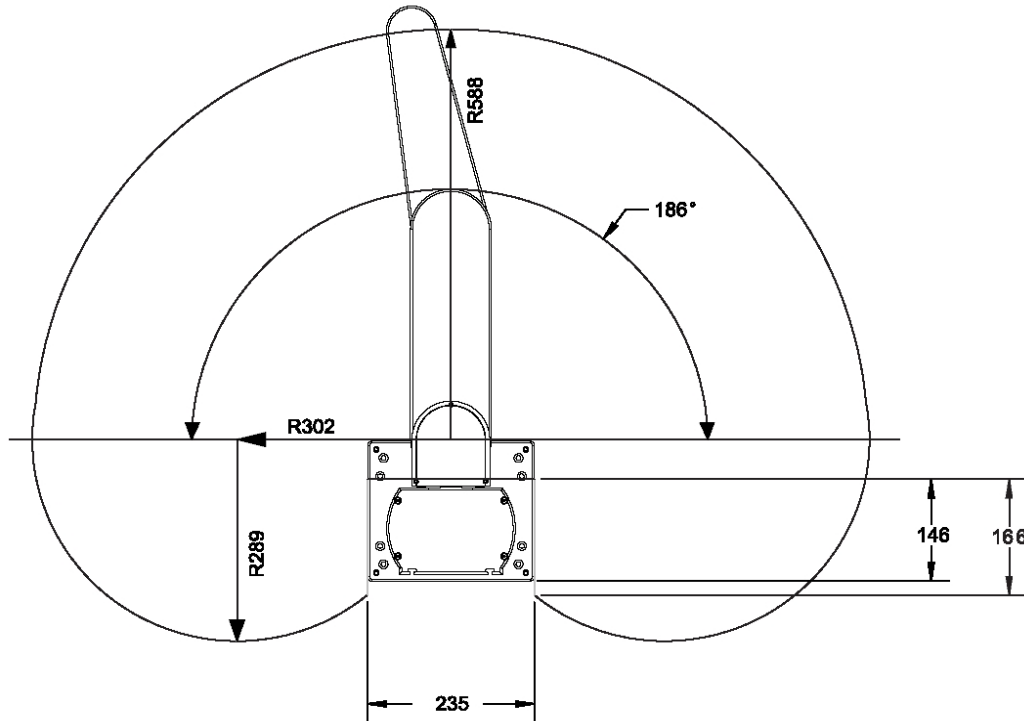
**PreciseFlex E-Gripper, Interface Drawing PF400**



### ISO Gripper Flange

### Work Envelope





Robot Height	Z Travel
712 mm	400 mm
1062 mm	750 mm
1472 mm	1160 mm

## Accessing the Robot Controller

Although most of the controller interface signals are exposed on the [Facilities Panel](#) at the base, there are times when it may be necessary to access either the robot's controller or its power supplies. To access the robot controller, the cover on the inner link must be removed by removing (4) M3 X 20 SHCS from the bottom of the inner link

See the *Guidance 1000A/B Controller* user manual for detailed information on hardware configuration and interfacing the controller using the various input and output ports such as those for digital I/O. Also, refer to the *Guidance System Setup and Operation Quick Start Guide* for information on configuring the PC and instructions on operating the robot. Both manuals are available in PDF format and are also contained in the *PreciseFlex Library*.

## Power Requirements

PreciseFlex robots' power supplies have an input range of 100 to 240 VAC, +/- 10%, 50/60 Hz. The robots are equipped with an IEC electrical socket that accepts country specific electrical cords. Power requirements vary with the robot duty cycle, but do not exceed 200 Watts RMS.

## Emergency Stop

It is necessary to wire an Emergency Stop Button to the controller. This button may be wired in series with other emergency stop contacts. The E-stop signals are available in the green Phoenix E-stop connector and the Manual Control Pendant 9-pin DSub connector that is mounted on the Facilities Panel. See [Hardware Reference](#) for detailed information on the E-stop signals.

## 4. Hardware Reference

### E-stop Connector

For users that wish to have a hardware E-stop button, Brooks offers an E-stop Box or a portable Hardware Manual Control Pendant that includes an E-stop button. The E-stop box can be plugged into the 9 pin D-Sub connector in the connector panel in the base casting. The E-stop box completes a circuit from Pin 1 (Estop 1) to Pin 6 (FE Out 1) and from Pin 2 (Estop 2) to Pin 7 (FE Out2) in this connector. If this circuit is not completed it is not possible to enable motor power to the robot. The FE Out signals allow each Estop circuit to be toggled during the CAT3 startup sequence to make sure both circuits are working. If no E-stop box or Manual Control Pendant is connected, jumpers must be connected between these four pins to enable robot motor power. For those applications where an operator must be inside the working volume of the robot while teaching, a second teach pendant with a 3-position run hold switch is available. The Manual Control Pendants can be plugged directly into the nine-pin Dsub connector mounted on the robot's Facilities Panel in the base of the robot.

The robot is shipped with a jumper plug in the nine-pin Dsub connector that satisfy these requirements. Unlike the Digital IO circuits, the E-stop circuit cannot be configured as "Sourcing" or "Sinking". If a remote signal (for example from a PLC) is used to trigger E-stop, it should be wired to a relay that closes the E-stop circuits.

### MCP/E-stop Interface

The MCP interface includes the signals necessary to connect a Manual Control Pendant or E-stop box. These signals are provided in a DB9 female connector mounted on the robot's Facilities Panel

If a Manual Control Pendant is not connected to the secondary RS-232 port provided in this connector, this serial interface can be accessed via a GPL procedure as device `"/dev/com2"` for general communications purposes. Note that unlike the primary serial interface, this secondary serial interface does not support flow control. See the tables below.

## Pin Outs &amp; Description

Pin	Description
1	E-stop_L1
2	E-stop_L2
3	RS232 RXD (Com 2)
4	24 VDC
5	NC
6	FORCE E-stop_L1 (Toggles E-stop Low at Start Up, Then High)
7	FORCE E-stop_L2 (Toggles E-stop Low at Start Up, Then High)
8	RS232 (Com2)
9	Gnd
Interface Panel Connector Part No	DB9 Female Connector AMP 5747150-7
User Plug Part No	DB9 Male Plug Amp 1658655-1 (crimp) Pins 22-26AWG 745254-6

## Fifteen-Pin D-Sub Signals

Pin	Description
1	24VDC
2	48VDC
3	GND
4	RS232 TXD (Com1)
5	OSSD1 (Output Signal Switching Device for Safety Devices)
6	RS485+
7	A+ (Belt)
8	B+ (Belt)
9	48 VDC
10	GND
11	RS232 RXD (Com1)
12	OSSD2 (Output Signal Switching Device for Safety Devices)
13	RS485-
14	A- (Belt)
15	B- (Belt)
Interface Panel Connector Part No	DB15 Female Connector AMP 5747299-7
User Plug Part No	DB15 Male Plug Amp 1658656-1 (crimp) Pins 22-26AWG 745254-6



## Digital Input and Output Signals

### Digital Input Signals

The standard PFDD robots provide twelve general-purpose optically isolated digital input signals at the Facilities Panel (in addition to those signals that are available at the Gripper Control Board). The input signals can be configured as "sinking" (Figure 4-1 and Figure 4-3) or "sourcing" (Figure 4-2 and Figure 4-4) in blocks of 4 by means of a software configuration setting. Set DataID 531 "DIN sink mode 1-4, 5-8, 9-12" to configure source vs. sink for digital input groups. 0 means sourcing, 1 means sinking. Output signals can be configured individually. Set DataID 530 "DOOUT sink mode 1, 2, 3, 4, 5, 6, 7, 8" to configure source vs. sink for digital outputs. 0 means sourcing, 1 means sinking. Changing any of these values clears all 8 digital outputs. If an input signal is configured as "sinking," the external equipment must pull its input high to 5VDC to 24VDC to indicate a logical high value or must allow it to float to no voltage for a logical low. This input is configured at the factory as "sinking."

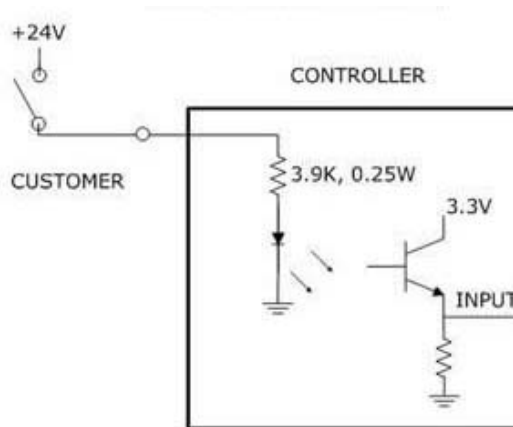
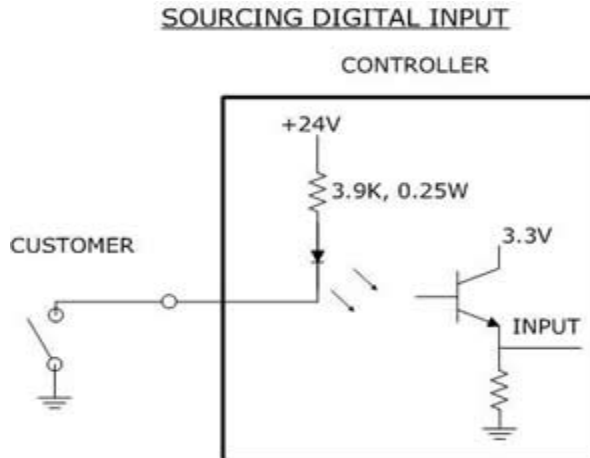


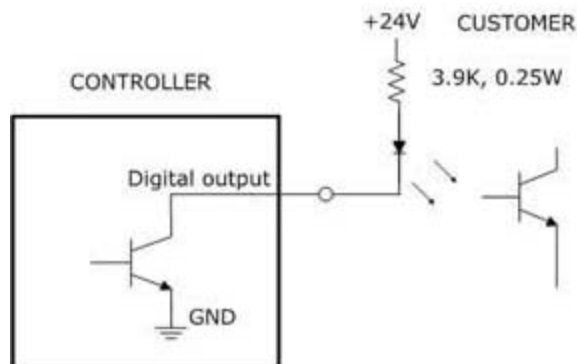
Figure 4-1: Sinking Digital Input



**Figure 4-2: Sourcing Digital Input**

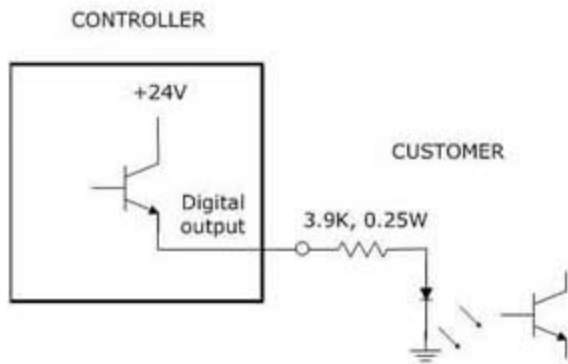
## Digital Output Signals

The PFDD robot provides 8 general-purpose optically isolated digital output signals in the 25-pin D-Sub connector on the facilities panel. These output signals can be individually configured as "sinking" or "sourcing" by means of a software setting. (See above.) **As shipped from the factory, the output signals are configured as "sourcing,"** i.e. the external equipment must pull down an output pin to ground and the controller pulls this pin to 24VDC when the signal is asserted as true.



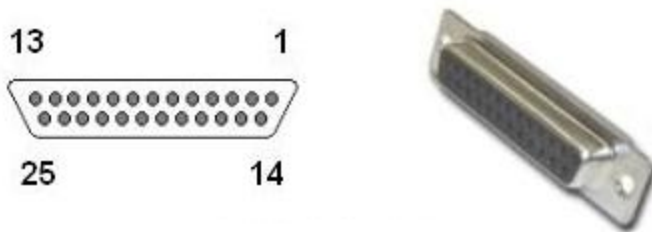
**Figure 4-3: Sinking Digital Output**

Alternately, the output signals can be configured as "sinking," i.e. the external equipment must pull down an output pin to ground and the controller pulls this pin to 24VDC when the signal is asserted as true.



**Figure 4-4: Sourcing Digital Output**

The pin out for the PFDD Digital Input and Output Connector (Figure 4-5) and the corresponding GPL signal numbers are described in the following table.



**Figure 4-5: DB25 Female Connector**

## 25-Pin D-Sub Signals

**Table 4-1: 25-Pin D-Sub Signals**

Pin	GPL Signal Number	Description
1		GND
2	10001	Digital Input 1
3	10003	Digital Input 3
4	10005	Digital Input 5
5	10007	Digital Input 7
6	10009	Digital Input 9
7	10011	Digital Input 11
8		24VDC
9	13	Digital Output 1

Pin	GPL Signal Number	Description
10	15	Digital Output 3
11	17	Digital Output 5
12	19	Digital Output 7
13		24VDC
14		GND
15	10002	Digital Input 2
16	10004	Digital Input 4
17	10006	Digital Input 6
18	10008	Digital Input 8
19	10010	Digital Input 10
20	10012	Digital Input 12
21		24VDC
22	14	Digital Output 2
23	16	Digital Output 4
24	18	Digital Output 6
25	20	Digital Output 8
User Plug Part No		Amp 1658657-1, (crimp) Pins 22-26AWG 745254-6

## Slave Amplifier (GSBP) Digital Inputs and Outputs

For each motor other the base motor, there is a slave amplifier that includes three sinking analog/digital inputs and three sourcing digital outputs (see [Table 4-2](#)). One digital output is dedicated for an LED light and has a 1,000 ohm resistor in series to limit the current. Three inputs and two outputs are available for application use. The digital inputs are each connected directly to Analog to Digital Converter inputs in the CPU, so they can be set by SW for 0-10VDC analog inputs (future feature) or 24VDC digital inputs (current release).

**Table 4-2: Slave Amplifier (GSBP) Digital Inputs and Outputs**

Pin	GPL Signal Number	Description
1	200013	Digital Output 1
2	200014	Digital Output 2
3	200015	Digital Output 3: LED driver (LED Out 3 Jumper Pins 2&3) OR TXD (Out 3 Jumper Pins 1&2)
4		24VDC output
5		GND

Pin	GPL Signal Number	Description
6	210001	Digital/Analog Input 1 (IN1 Jumper Pins 2&3) OR RXD (IN1 Jumper Pins 1 &2)
7	210002	Digital/Analog Input 2
8	210003	Digital/Analog Input 3
User Plug Part No		TE 794617-8, Pins 794610-1 (20-24AWG Tin)

## Ethernet Interface

PFDD robots include an Ethernet switch that implements two 10/100 Mbit Ethernet ports. This capability was designed to permit the controller to be interfaced to multiple Ethernet devices such as other PreciseFlex™ controllers or robots, remote I/O units, and Ethernet cameras. The Ethernet switch automatically detects the sense of each connection, so either straight-through or cross-over cables can be used to connect the controller to any other Ethernet device.

Due to limited space on the Facilities Panel, only one of the two Ethernet ports is available via an external RJ45 connector. This external Ethernet port is typically used to interface the robot to a PC. The second Ethernet port is only available inside the inner link of the robot. In some cases, it may be used to connect an Ethernet camera that is mounted on the robot.

In this case, a PC that is connected to the Ethernet plug on the Facilities Panel can communicate with the robot's controller as well as receive images from an arm-mounted camera. (For the initial release of this robot, arm mounted cameras are not supported.)

If a camera is mounted in the workcell, an external Ethernet switch must be added to connect these cameras and the robot to a PC.

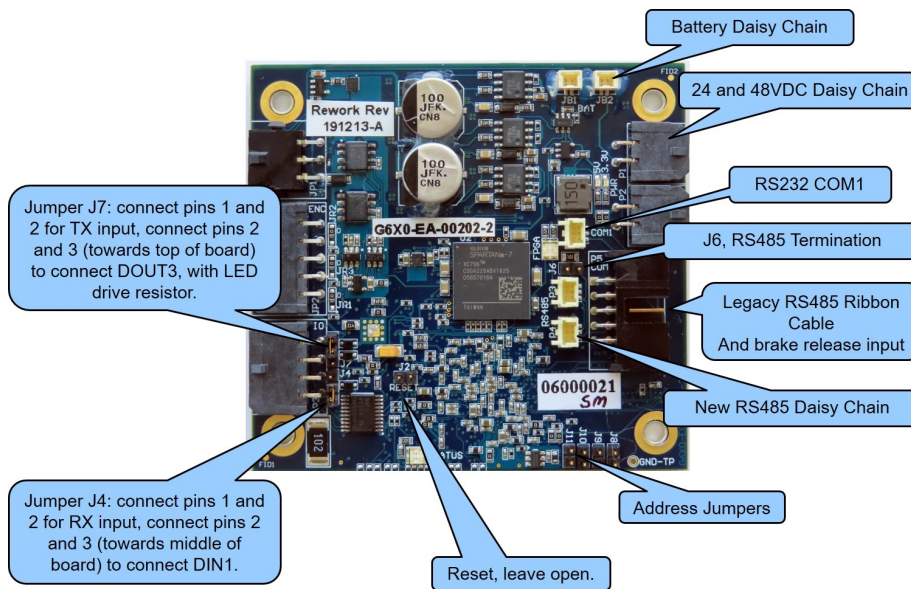
See the *Setup and Operation Quick Start Guide* for instructions on setting the IP address for the controller.

## RS-232 Serial Interface

The PFDD robot includes a standard RS-232 serial line equipped with hardware or software flow control. This port is available on the 15-pin D-sub connector on the connector panel in the base of the robot as COM1. This port can be used to communicate to the system serial console or can be connected to external equipment for general communication purposes. When used for general communications, this port is referenced as device "/dev/com1" within the Guidance Programming Language (GPL).

## Gripper Serial Interface (for Bar Code and other RS232 devices in Gripper)

It is possible to connect a bar code reader or other RS232 serial device to the slip ring located in the robot gripper. In the GSBP gripper, two IO pins have optional assignments based on jumpers. For J4 connect pins 2 and 3 to connect Digital Input 1 to pin 6 and connect pins 1 and 2 to connect pin 6 to a line that goes back to a CPU serial input where it is multiplexed onto RS485 to connect back the main controller COM1 input. For J7 connect pins 2 and 3 to connect Digital Output 3 to pin 3 and connect pins 1 and 2 to connect pin 3 to a line that goes back to a CPU serial input where it is multiplexed onto RS485 to connect back the main controller COM1 input. Serial data rate is limited to 9600 baud. (Not available in beta units)



**Figure 4-6: J4 and J7 on GSB Board**

Refer to Slip Ring drawings in Hardware Reference Section for the slip ring connector pin assignments inside the grippers. The mating connector is TE (Amp) Micro Mate N Lok PN 794617-6 with contacts PN 1-794611-2. It is recommended that 24V bar-code readers be used as the 5 V supply is very limited.

Several bar code readers that have been successfully implemented with PreciseFlex Robots are the following:

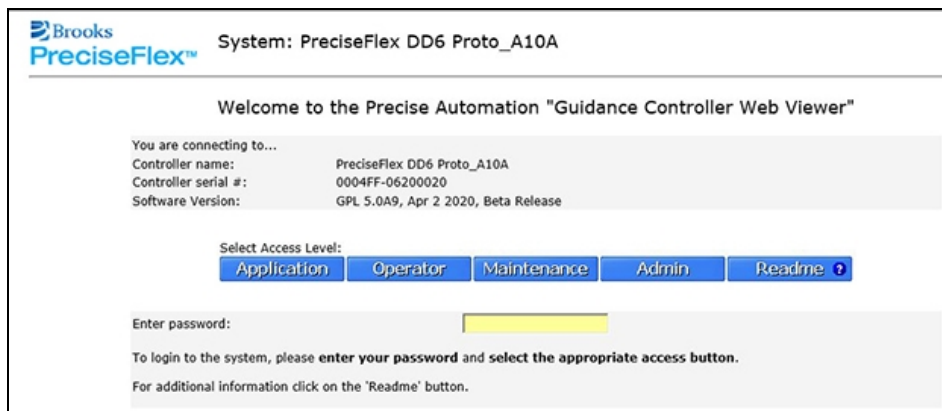
1. Keyence SR750, 1D and 2D, 24VDC supply, 200 ma, 60 mm distance
2. Cognex DM50, DM60, DM70, 24VDC supply, 500 ma, 45 to 110 mm distance
3. Omron/Microscan MiniHawk, 1D and 2D, 5VDC supply, need converter from 24VDC

## 5. Software Reference

### Accessing the Web Server

Many OEM customers run Brooks Robots using a PC to provide an application-specific operator interface. In order to update software in the controller, and view certain error messages, it is necessary to access the Web Server Interface embedded in the controller.

The Web Server Interface may be addressed by opening a browser in a PC that is connected to the robot via Ethernet. The user must know the IP address of the robot controller. Two common IP addresses are 192.168.0.1 and 192.168.0.10. The PC LAN interface address must be configured correctly (for example 192.168.0.100, with subnet mask 255.255.255.0). The Web Server Interface will display (Figure 5-1).



**Figure 5-1: Web Server Interface**

It may be necessary to enter a password if a company has protected access to the Web Interface. Once the password has been entered, click **Admin** to access all the features to perform system upgrades. The *System Setup* window will display (Figure 5-2).

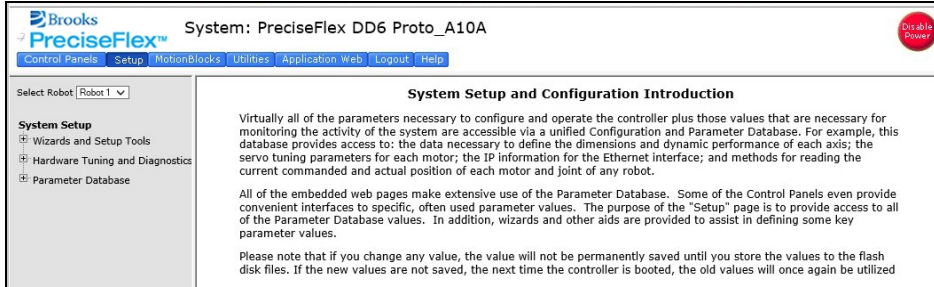


Figure 5-2: System Setup

Click **Control Panels** and then **Operator Control Panel**. The *Operator Control Panel* window (Figure 5-3) will display.

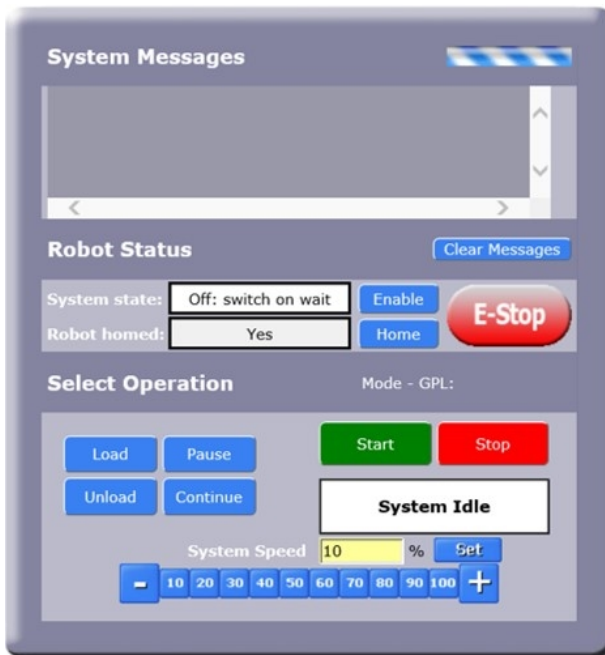


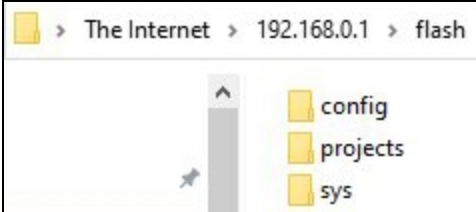
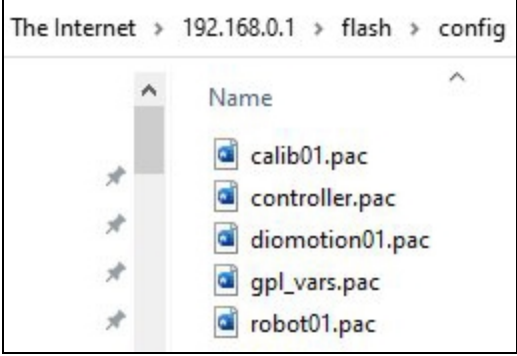
Figure 5-3: Operator Control Panel

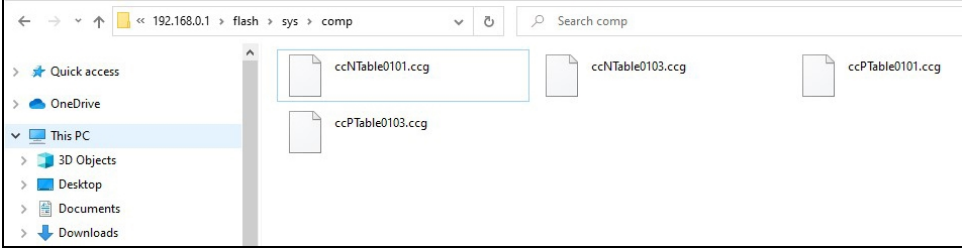
If an application is running, the *System Running* panel will display in green. In order to run diagnostics, the user must stop the application from running. Click **Stop**. This will stop the application from running. Click **Disable Power** to ensure that the motor power is off. To load a new project (for example CAL\_PP), click **Unload** and then **Load** before loading the new project into RAM.



## Loading a Project (Program) or Updating PAC Files


If CAL\_PP or a different program needs to be loaded into the controller from an external computer, this may be done via FTP. Previous generations of GPL supported this process directly from the GPL Web Server, but Windows 10 and Edge no longer allow this. To load a project (program) or update PAC files, complete the following steps.

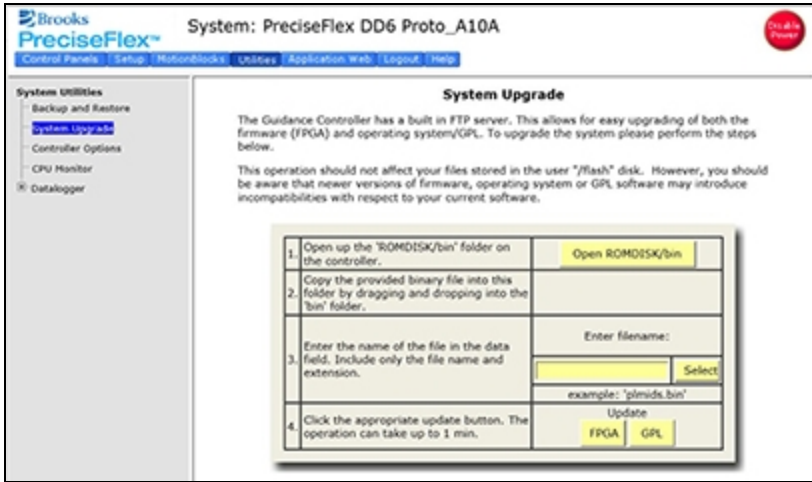
Step	Action
1.	<p>Use the File Explorer to access the flash directly. For example, type "<a href="ftp://192.168.0.1/flash">ftp://192.168.0.1/flash</a>" in the File Explorer address line if the controller is set to the default address 192.168.0.1. Otherwise, use the controller IP address. This should bring up a window with the following files:</p> 
2.	<p>To load a GPL Project, such as CALPP, Open the <b>Projects</b> folder and paste the project folder into this area. There may be several other projects (programs) loaded into this folder, which is stored in flash ram in the controller. A project folder is a software folder than may have several files inside it. The entire folder must be loaded, not just the files inside.</p>
3.	<p>Once the appropriate project (for example CAL_PP) has been loaded into flash memory, it must then be loaded into dynamic memory in order to execute. See the following section on "<a href="#">Calibrating the Robot: Setting the Encoder Zero Positions</a>" on page 1 for an example on how to load and execute the CAL_PP program.</p>
4.	<p>To load or update PAC files, open the <b>Config</b> folder and paste a backup copy of the PAC files into the <b>Config</b> folder. These files will all have a <b>.pac</b> extension. Wait at least 15 seconds after the copy is complete before turning off the controller. Reboot the robot after the new PAC files are installed for them to take effect.</p> 

Step	Action
<b>5.</b>	<p>To update the DD motor cogging compensation tables, go back up to the top-level directory and open the FLASH file, then open the sys file, then open the comp file. Paste the new cogging compensation tables into the comp file, wait 15 seconds, and then reboot the controller.</p> 

## Updating GPL (System Software and Firmware)

GPL (the system software and firmware are now a single file in GPL 5.0 and later) may be upgraded in the field. To update GPL (system software and firmware), complete the following steps:

Step	Action
<b>1.</b>	Get the appropriate upgrade software from Precise Collaborative Robotics, in the form of a .gz file.
<b>2.</b>	<p>Use the File Explorer to access the ROMDISK GPL storage area directly. Type "<a href="ftp://192.168.0.1/ROMDISK/bin">ftp://192.168.0.1/ROMDISK/bin</a>" in the File Explorer address line.</p> 
<b>3.</b>	Paste the new GPL system file into this folder.

Step	Action
4.	<p>Using the Web Interface, under <b>Utilities</b>, click <b>System Upgrade</b>.</p> 
5.	<p>Ignore the <b>Open ROMDISK/bin</b> button. This is for older versions of Windows. In box 3, click the <b>Select</b> button. A pop-up window will open showing the contents of the ROMDISK/bin folder. Highlight the <b>GPL</b> file and click <b>Select</b> in the pop-up window.</p>
6.	<p>In box 4, click <b>Update GPL</b>. Wait until the Update Complete message appears. Then wait 15 seconds for the flash to store the data and reboot the controller for the new version of GPL to take effect.</p>

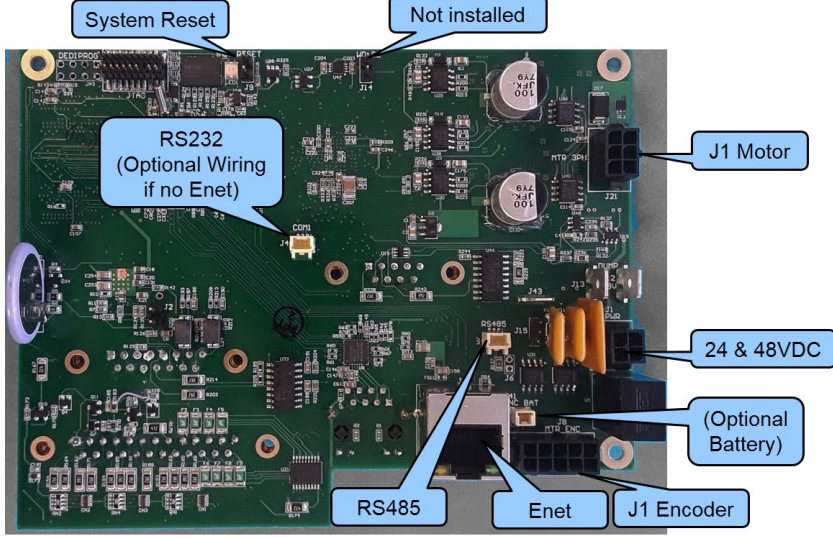
## Recovering from Corrupted PAC Files

PAC files are configuration files that determine the configuration of the robot for the software, including the robot factory calibration data. These files are stored in Flash RAM. Flash RAM is also used to store robot programs. The Flash RAM requires some time for a complete write cycle. During the write cycle, the console will display a flashing warning not to turn off robot power. If robot power is turned off during the Flash RAM write cycle, the Flash data may be lost or corrupted. If this happens, it is necessary to reload both the robot PAC files and any user programs that were stored in Flash RAM. This problem should typically not be encountered by a user unless the user is changing configuration files in the robot and fails to wait a sufficient amount of time for the flash to be saved before turning off power.

Brooks maintains a record of PAC files shipped with each robot Serial Number. If the PAC files have been corrupted, it is possible to get a backup copy from Brooks. The backup copy will contain the factory configuration and calibration data, but will not contain any changes, including any new calibration data, made after the robot has left the factory.

In order to allow the controller to recover from corrupted PAC files, a set of recovery boot up PAC files is loaded in the system area of the Flash.

To configure the controller to boot up in recovery mode, complete the following steps:

Step	Action
1.	Obtain a set of backup PAC Files from Precise or local backup.
2.	Remove the screws holding the connector panel in the base of the robot to access the PCA.
3.	<p>Move Jumper J9 (System Reset) so that it connects the two jumper posts. This will cause the factory default configuration files to be loaded at controller boot up.</p> 
4.	Cycle robot power to reboot the controller.
5.	Follow the procedure above for updating PAC files.

# Appendices

## Appendix A: PFDD4 Product Specifications

General Specification	Range
<b>PERFORMANCE</b>	
Payload	8 kg
Max Cartesian Speed	X/Y Direction, 500 mm/sec Z Direction, 600 mm/sec
Max Joint Speed	J1 - 200°/sec J2 - 600 mm/sec J3 - 360°/sec J4 - 540°/sec
Max Acceleration	5000 mm/sec <sup>2</sup> with 6 kg payload
Repeatability	±0.020 mm at tool flange center
<b>RANGE OF MOTION</b>	
Joint 1 (base)	±168°
Joint 2 (Z-axis)	500, 1000, 1420 mm
Joint 3 (Elbow)	+11.5° to +348.5°
Joint 4	±249°
Horizontal Reach	896 mm
<b>COMMUNICATIONS</b>	
General	100 Mb Ethernet, TCP/IP EtherNet/IP RS232 Modbus/TCP
Operator Interface	Web-based operator interface
Digital I/O	12 inputs, 8 outputs at base of robot Optically isolated, 24 V @ 100 ma Remote I/O available
<b>FACILITIES</b>	
Power	90 to 264 VAC, auto selecting, 50-60 Hz 70-175 watts typical operation DC power option available
Pneumatics	Two 6 mm airlines provided for end-of-arm-tooling 4.9 bar max (71 PSI) Flow rate of 70 L/min (2.5 SCFM)
E-Stop	Dual channel
Controller Mounting	Embedded into robot base

General Specification	Range
Air Lines	Two, 3.2 mm OD, 1.6 mm ID Max pressure 500 kpa (75 PSI)
Weight	44 kg (500 mm Z-axis) 53 kg (1000 mm Z-axis) 63 kg (1420 mm Z-axis)
Noise Level	< 50 dB(A)
<b>SOFTWARE</b>	
Programming	Guidance Motion (web interface) Guidance Programming Language (GPL) TCP Command Server (TCS)
Enhanced Functions	Hand Guiding (standard)
<b>PERIPHERALS AND ACCESSORIES</b>	
General	23N Servo Gripper Dual 23N Servo Gripper 60N Servo Gripper Remote I/O (RIO)
Vision	PreciseVision Gripper, 23 N PreciseVision Gripper, 60 N

## Appendix B: PFDD6 Product Specifications

General Specification	Range
<b>PERFORMANCE</b>	
Payload	6 kg
Max Cartesian Speed	X/Y direction, 500 mm/sec Z direction, 600 mm/sec
Max Joint Speed	J1 200°/sec J2 600 mm/sec J3 360°/sec J4 360°/sec J5 200°/sec J6 360°/sec
Max Acceleration	5000 mm/sec <sup>2</sup> with 6 kg payload
Repeatability	+/-0.020 mm at tool flange center
<b>RANGE OF MOTION</b>	
Joint 1 (base)	+/- 169.5°
Joint 2 (Z-axis)	500, 1000, 1420 mm
Joint 3 (Elbow)	+11.5° to + 348.5°
Joint 4	+100° to -120°
Joint 5	+/-110°
Joint 6	+/-295°
Horizontal Reach	896 mm
<b>COMMUNICATIONS</b>	
General	100 Mb Ethernet, TCP/IP EtherNet/IP RS232 Modbus/TCP
Operator Interface	Web-based operator interface
Digital I/O	12 inputs, 8 outputs at base of robot Optically isolated, 24 V @ 100 ma Remote I/O available
<b>FACILITIES</b>	
Power	90 to 264 VAC, auto selecting, 50-60 Hz 70-175 watts typical operation DC Power Option Available
Pneumatics	Two 6 mm airlines provided for end-of-arm-tooling 4.9 bar max (71 PSI) Flow rate of 70 L/min (2.5 SCFM)
E-Stop	Dual Channel



General Specification	Range
Controller Mounting	Embedded into robot base
Air Lines	Two, 3.2 mm OD, 1.6 mm ID, max pressure 500 kpa (75 psi)
Weight	46 kg (500 mm Z-axis) 55 kg (1000 mm Z-axis) 65 kg (1420 mm Z-axis)
<b>SOFTWARE</b>	
Programming	Guidance Motion (web interface) Guidance Programming Language (GPL) TCP Command Server (TCS)
Enhanced Functions	Hand Guiding (standard)
<b>PERIPHERALS AND ACCESSORIES</b>	
General	Remote I/O (RIO)
Vision	PreciseVision Gripper, 23 N PreciseVision Gripper, 60 N

## Appendix C: Environmental Specifications

The PFDD Robots must be installed in a non-condensing environment with the specifications from the table below.

Environmental Specifications

General Specification	Range & Features
Indoor use only	
Ambient temperature	4° C to 40° C
Storage and shipment temperature	-25° C to +55° C
Humidity range	10 to 90%, non-condensing
Altitude	Up to 3000 m
Voltage	100-240 VAC +/- 10%, 50/60 Hz
Mains cord rating, min	16AWG, 3 conductor, 10 Amps min
Pollution Degree	2
Approved Cleaning Agents	IPA, 70% Ethanol/30% water, H2O2 Vapor up to 1000 ppm
IP Rating with Tape Seal Option	52
IP Rating without Tape Seal Option	11
IK Impact Rating	IK08: 5 Joule

## Appendix D: Spare Parts List

**NOTE:** Email [support\\_preciseflex@brooksautomation.com](mailto:support_preciseflex@brooksautomation.com) for help replacing spare parts.

Reference - the serial number format is:

- FD0-yymm-XY-zzzzz
- Yy – year
- Mm – month
- X – controller rev
- Y – robot rev
- Zzzzz – unique number

### Spare Parts List

Description	Part Number
Absolute Encoder Battery	G1S0-EC-X0007
J2 Stage 1 Belt	PFD0-MC-X0006
J2 Stage 2 Belt 500 mm	PFD0-MC-X0003
J2 Stage 2 Belt 1000 mm	PFD0-MC-X0003
J2 Stage 2 Belt 1420 mm	PFD0-MC-X0003
J2 400 W Motor	PFD0-MA-00053
J4 Stage 1 Belt	PFD0-MC-X0050
J4 Stage 2 Belt	PFD0-MC-X0051
Main Controller with Complex Kinematics License	PFD0-EA-00001-3
Slave Controller GSBP 20A with motor connector pigtail and thermal pad for Z	G6X0-EA-01202-3A
Slave Controller GSBP 20A no thermal pad	G6X0-EA-00202-3A
Slave Controller GSBP 10A single ended for 23 N grip	G6X0-EA-00101-3A
J4 400 W Motor for PFDD4 with pulley	PFD0-MA-00029
Assy, J4, HD PFD0	PFD0-MA-00041
Assy, J5 & J6, HD, PFD0	PFD0-MA-00046
PF400 23N Servo Gripper with Spring, without fingers	PF0S-MA-00001-2
J3 Clockspring Harness	PFD0-MA-00021-X2
J4 to Gripper Harness in PFDD4	PFD0-MA-00017
J4 to J5 Harness in PFDD6	PFD0-MA-00016
J5 to J6 Harness in PFDD6	PFD0-MA-00017
J6 Motor and Encoder Pigtail	PFD0-MA-00010-X3
24VDC Supply	PS10-EP-24150
48VDC Motor Supply	PS10-EP-481000
Slip Ring Harness Assembly, 23 N Spring Gripper	PF04-MA-00010-E7
Solenoid Valve	PF05-MC-X0001
Energy Dump Resistor Assembly	PFD0-MA-00024
O-Rings for Front Cover dowel pins (2)	0000-HC-X0051

## Appendix E: Preventative Maintenance

Every one to two years, perform the following preventative maintenance procedures. For robots that are continuously moving 24 hours per day, 7 days a week at moderate to high speeds, Brooks recommends a one-year schedule. For robots with low duty cycles and low to moderate speeds, perform these procedures at least once every two years.

### Preventative Maintenance



	Procedure If Problem Detected
Check all belt tensions.	Re-tension if necessary.
Check air harness tubing in elbow if present, and theta axis for any wear.	Replace if necessary.
Check second stage (long) Z belt for any squeaking.	If noisy, add thick grease to front and rear edge of belt if necessary. (Shell 222 XP or similar). Z timing belt can get stiffer over time (2-3 years) and occasionally start squeaking against pulley flanges.
Check if front cover is rattling.	If so, check .125 in ID by .062 in thick O rings on dowel pins in base plate under front cover for any deterioration and replace if necessary.
Replace slip ring in DD4 if present.	For units with 23 N electric replace the slip ring every third inspection test, or 20,000 hours of operation.



---

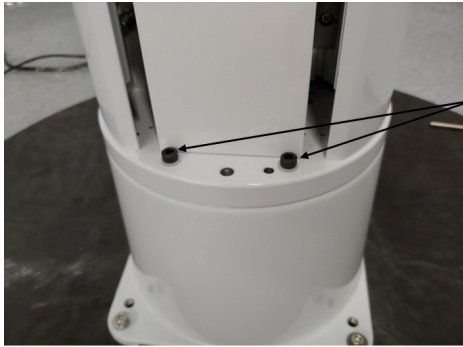

**NOTE:** See the PreciseFlex DD Service Procedures manual for detailed instructions on how to perform each inspection and maintenance operation.

---

## Appendix F: Unpacking the Robot

Step	Action
1.	 <p>Release latches on crate. Once released, the top and three sides can be lifted vertically off to expose the robot and accessory box. No screws need to be removed.</p>
2.	 <p>Handle Parts and Accessories Box Here</p> <p>Handle Parts and Accessories should include:</p> <ul style="list-style-type: none"><li>• One Ethernet Cable</li><li>• One Power Cable</li><li>• One Calibration Pin Bag</li><li>• One Estop Jumper</li><li>• Two M6-50 SCHS for Top Handle</li><li>• Two M10-20 fine SHCS for Lower Handle</li><li>• Two Handles for Moving Robot</li></ul>

Step	Action
3.	 <p data-bbox="326 863 1044 961">Attach handle to base assembly using two M10-20 Fine Pitch SHCS (McMaster 96144A262)</p>
4.	 <p data-bbox="878 1150 1325 1241">Remove bag prior to transporting robot to it's mounting location</p> <p data-bbox="326 1633 1138 1732"> <ol style="list-style-type: none"> <li>1. Remove two screws from endcap</li> <li>2. Attach handle using two M6-50 SHCS from Handles and Accessories box.</li> </ol> </p>

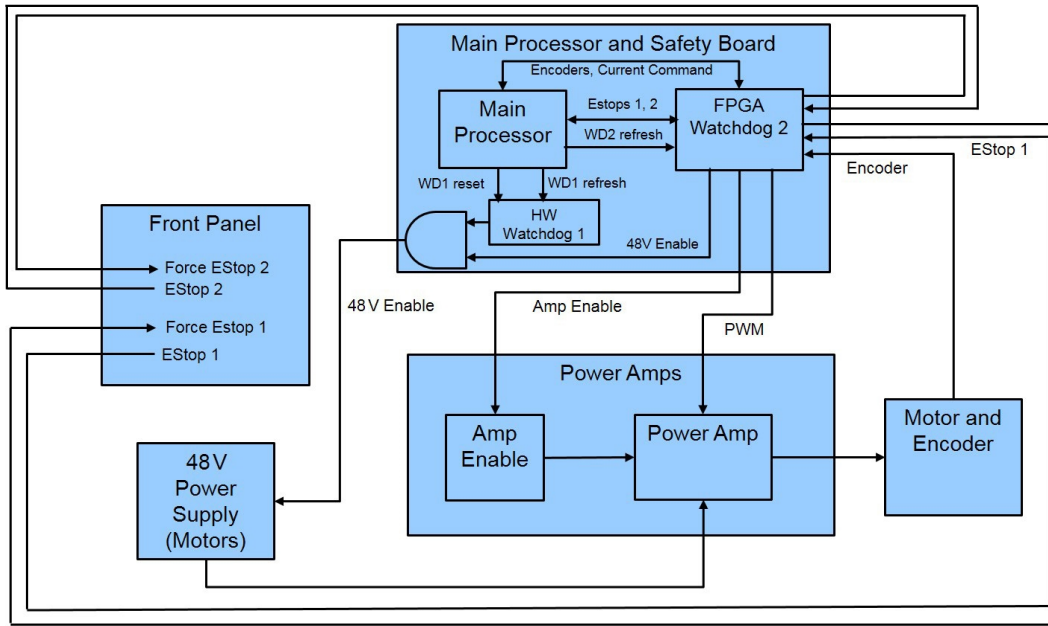
Step	Action
5.	 <p data-bbox="792 304 1242 436">These bolts restrain rotation of base with arm straight out. Use two M6-50 SHCS (McMaster-Carr 91290A205) and two M6 Nylon Washers (McMaster-Carr 95610A570 ). Torque to hand tight.</p> <p data-bbox="792 541 1242 646"><b>Make sure these bolts are removed prior to operating robot after robot is bolted in place. These should be installed before any lifting of the robot occurs.</b></p>
6.	 <ol data-bbox="716 772 1258 1136" style="list-style-type: none"><li>1. With two people, lower robot onto mounting surface and tilt up slightly to remove the lower base handle.</li><li>2. Tip robot fully upright and mount secure while supporting robot. Robot must not be unsupported until securely bolting to mounting surface.</li><li>3. Remove handles from top and replace top endcap screws.</li><li>4. Remove lower anti rotation bolts and nylon washers.</li><li>5. Remove Velcro arm restrains.</li><li>6. Install Estop Jumper D-Sub</li></ol>

## Appendix G: Safety Circuits for PFDD Robots

14-Jun-19	PFDD Robots								
Safety Circuit	Start up Test :	Redundant	Continuous Test	Diagnostic Coverage	MTTF <sub>h</sub> , Years	Power Off On Failure	PL	Category Safety	
									Notes (PF3400t has redundant Estop and 48V power supply enable)
Estop	Yes	Yes	No	99%	100	Yes	d	3	Startup test forces Estop, checks 48V power disable, zero amp current Dual Estop circuits turns off amp enable and PWM Dual Estop circuits turns off 48V power Stopping robot with hand turns off amp enable, PWM and 48V
Encoder Feedback	Yes	No	Yes	90%	58	Yes	d	3	Startup test checks encoder communication, prevents mtr power if fault Serial update at 8Khz w checksum, comm check, accel check Counter embedded in position word to confirm CPU read from FPGA
CPU Monitor	Yes	Yes	Yes	99%	100	Yes	d	3	Startup test forces CPU WD low, checks 48V power disabled Independent dual watchdog timers turn off amp enable, PWM and 48V Processor on safety board monitors main CPU. Disables 48V if failure.
Position Envelope Error	Yes	Yes	Yes	90%	57	Yes	d	3	Startup test checks encoder communication, prevents mtr power if fault Serial update at 8Khz w checksum, comm check, accel check SW watchdog in servo loop turns off amp enable, PWM and 48V Counter embedded in position word to confirm CPU read from FPGA
Power amp Fault	Yes	Yes	Yes	90%	100	Yes	d	3	Startup test confirms zero current when 48V enabled Excess current to ground or phase to phase triggers shutdown in 10 usec Saturated PID current command triggers shutdown in .050 sec Shorted transistor just locks up brushless motor
Collab Force Limit	Yes	Yes	Yes	90%	5W	Yes	d	3	Tests 2, 3, 4 above test HW. Motor driven against brake to test 5W current limit. Position envelope error triggers fault, turns off power at amp and 48V Current saturation triggers separate fault, turns off power at amp and 48V Monitor function with WD turns off power at amp and 48V Monitor and CPU WD tested at startup turning off 48V Assymmetric current limits limit Z force even with gravity load
Velocity Restrict	Yes	Yes	Yes	99%	93	Yes	d	3	Startup test, sets flag to trigger this error, then resets Checks velocity limit in FPGA in addition to check in CPU servo software
									1. Cat 2 and Cat 3 require startup test before enabling motor power

### Safety Circuits for PFDD Robots





**Safety Circuits for PFDD Robots**

## Appendix H: Example Performance Level Evaluation for the PFDD

**Example Workcell description:** A PFDD4 moves 100-gram plastic trays from storage racks to an instrument and back to the storage racks. Gripper is an electric parallel jaw gripper with maximum 23 N of gripping force for plastic trays and is spring loaded so it will not drop trays if power fails. Robot motion is programmed with approach point 50 mm above the instrument tray and final motion into instrument is made at 50 mm/sec. Lowest storage rack position is 50 mm above table surface.



Example PF400 Workcell: Courtesy of Biosero

### Normal Operator Interaction with robot:

Teaching locations in workcell by hand guiding or teach pendant. Maximum robot forces under manual control from PFDD Table 1 are 105 N. Pausing robot and removing racks from workcell with safety interlocks in workspace. Robot is stopped.

### Possible Low Frequency (rare) Interaction with Robot:

Untrained operator reaches into workcell while robot is moving and robot collides with operator. Maximum free space collision force from PFDD Table 1 is 182 N, which is below free space collision for 500 ms maximum of 280 N. Untrained operator reaches into workcell while robot is moving into instrument tray and hand is trapped between robot and instrument tray. From PFDD Table 1 max trapping force in downwards Z direction at 60 mm/sec (10% of max speed of 600 mm/sec) is 77N.

Performance Level: From the above, based on ISO 13849-1:2006:

- S is S1, as possible operator collision forces will not injure operators.
- F is F1 as normal operation does not involve collisions with robot.
- P is P1 as the robot does not make unexpected motions

So PL is “a,” and even a Category B controller is sufficient given the low speeds and small possible collisions forces involved which cannot injure an operator. (See 5.2.3 under [EN/ISO 10218-1:2011](#)).

## Appendix I: Table A2 from ISO/TS 15066: 2016

Biomechanical limits

Body region	Specific body area	Quasi-static contact		Transient contact	
		Maximum permissible pressure <sup>a</sup> $p_s$ N/cm <sup>2</sup>	Maximum permissible force <sup>b</sup> N	Maximum permissible pressure multiplier <sup>c</sup> $P_T$	Maximum permissible force multiplier <sup>c</sup> $F_T$
<i>Skull and forehead<sup>d</sup></i>	1 <i>Middle of forehead</i>	130	130	not applicable	not applicable
	2 <i>Temple</i>	110		not applicable	
<i>Face<sup>d</sup></i>	3 <i>Masticatory muscle</i>	110	65	not applicable	not applicable
Neck	4 Neck muscle	140	150	2	2
	5 Seventh neck muscle	210		2	
Back and shoulders	6 Shoulder joint	160	210	2	2
	7 Fifth lumbar vertebra	210		2	
Chest	8 Sternum	120	140	2	2
	9 Pectoral muscle	170		2	
Abdomen	10 Abdominal muscle	140	110	2	2
Pelvis	11 Pelvic bone	210	180	2	2
Upper arms and elbow joints	12 Deltoid muscle	190	150	2	2
	13 Humerus	220		2	
Lower arms and wrist joints	14 Radial bone	190	160	2	2
	15 Forearm muscle	180		2	
	16 Arm nerve	180		2	

<sup>a</sup> These biomechanical values are the result of the study conducted by the University of Mainz on pain onset levels. Although this research was performed using state-of-the-art testing techniques, the values shown here are the result of a single study in a subject area that has not been the basis of extensive research. There is anticipation that additional studies will be conducted in the future that could result in modification of these values. Testing was conducted using 100 healthy adult test subjects on 29 specific body areas, and for each of the body areas, pressure and force limits for quasi-static contact were established evaluating onset of pain thresholds. The maximum permissible pressure values shown here represent the 75th percentile of the range of recorded values for a specific body area. They are defined as the physical quantity corresponding to when pressures applied to the specific body area create a sensation corresponding to the onset of pain. Peak pressures are based on averages with a resolution size of 1 mm<sup>2</sup>. The study results are based on a test apparatus using a flat (1,4 × 1,4) cm (metal) test surface with 2 mm radius on all four edges. There is a possibility that another test apparatus could yield different results. For more details of the study, see Reference [5].

<sup>b</sup> The values for maximum permissible force have been derived from a study carried out by an independent organization (see Reference [6]), referring to 188 sources. These values refer only to the body regions, not to the more specific areas. The maximum permissible force is based on the lowest energy transfer criteria that could result in a minor injury, such as a bruise, equivalent to a severity of 1 on the Abbreviated Injury Scale (AIS) established by the Association for the Advancement of Automotive Medicine. Adherence to the limits will prevent the occurrence of skin or soft tissue penetrations that are accompanied by bloody wounds, fractures or other skeletal damage and to be below AIS 1. They will be replaced in future by values from a research more specific for collaborative robots.

<sup>c</sup> The multiplier value for transient contact has been derived based on studies which show that transient limit values can be at least twice as great as quasi-static values for force and pressure. For study details, see References [2], [3], [4] and [7].

<sup>d</sup> Critical zone (*italicized*)

### Biomechanical Force & Pressure Limits

Table A.2 (continued)

Body region	Specific body area		Quasi-static contact		Transient contact	
			Maximum permissible pressure <sup>a</sup> $p_s$ N/cm <sup>2</sup>	Maximum permissible force <sup>b</sup> N	Maximum permissible pressure multiplier <sup>c</sup> $P_T$	Maximum permissible force multiplier <sup>c</sup> $F_T$
Hands and fingers	17	Forefinger pad D	300	140	2	2
	18	Forefinger pad ND	270		2	
	19	Forefinger end joint D	280		2	
	20	Forefinger end joint ND	220		2	
	21	Thenar eminence	200		2	
	22	Palm D	260		2	
	23	Palm ND	260		2	
	24	Back of the hand D	200		2	
	25	Back of the hand ND	190		2	
Thighs and knees	26	Thigh muscle	250	220	2	2
	27	Kneecap	220		2	
Lower legs	28	Middle of shin	220	130	2	2
	29	Calf muscle	210		2	

<sup>a</sup> These biomechanical values are the result of the study conducted by the University of Mainz on pain onset levels. Although this research was performed using state-of-the-art testing techniques, the values shown here are the result of a single study in a subject area that has not been the basis of extensive research. There is anticipation that additional studies will be conducted in the future that could result in modification of these values. Testing was conducted using 100 healthy adult test subjects on 29 specific body areas, and for each of the body areas, pressure and force limits for quasi-static contact were established evaluating onset of pain thresholds. The maximum permissible pressure values shown here represent the 75th percentile of the range of recorded values for a specific body area. They are defined as the physical quantity corresponding to when pressures applied to the specific body area create a sensation corresponding to the onset of pain. Peak pressures are based on averages with a resolution size of 1 mm<sup>2</sup>. The study results are based on a test apparatus using a flat (1.4 × 1.4) cm (metal) test surface with 2 mm radius on all four edges. There is a possibility that another test apparatus could yield different results. For more details of the study, see Reference [5].

<sup>b</sup> The values for maximum permissible force have been derived from a study carried out by an independent organization (see Reference [6]), referring to 188 sources. These values refer only to the body regions, not to the more specific areas. The maximum permissible force is based on the lowest energy transfer criteria that could result in a minor injury, such as a bruise, equivalent to a severity of 1 on the Abbreviated Injury Scale (AIS) established by the Association for the Advancement of Automotive Medicine. Adherence to the limits will prevent the occurrence of skin or soft tissue penetrations that are accompanied by bloody wounds, fractures or other skeletal damage and to be below AIS 1. They will be replaced in future by values from a research more specific for collaborative robots.

<sup>c</sup> The multiplier value for transient contact has been derived based on studies which show that transient limit values can be at least twice as great as quasi-static values for force and pressure. For study details, see References [2], [3], [4] and [7].

<sup>d</sup> Critical zone (*italicized*)

### Biomechanical Force & Pressure Limits

## Appendix J: ISO TS 15066 Test Results, Transient Contact

Transient contact testing with 1, 4, and 8 kg payloads. Forces in green, below, mean that they are within specification.

1kg										
		Cartesian (XY,Z)			J1			J3		
	acc/dec	100/100	100/100	100/50			25/25			300/300
	dist. (mm)	50	50	50			150			92
	dist. (deg)	-	-	-			15			15
Speed (%)	mm/s	X(N)	Y(N)	Z(N)	deg/s	mm/s	J1(N)	deg/s	mm/s	N
10	60	4	12	19	12	115	18	36	220	35
20	120	16	20	37	24	230	35	72	440	68
40	240	31	40	66	48	461	70	144	879	132
60	360	51	62	84	72	691	136	216	1319	185
80	480	67	78	102	96	921	212	288	1758	205
100	600	83	87	123	120	1151	243	360	2198	210
4 kg *										
		Cartesian (XY,Z)			J1			J3		
	acc/dec	100/100	100/100	100/100			25/15			300/300
	dist. (mm)	50	50	50			150			92
	dist. (deg)	-	-	-			15			15
Speed (%)	mm/s	X(N)	Y(N)	Z(N)	deg/s	mm/s	J1(N)	deg/s	mm/s	N
10	60	11	4	22	12	115	21	36	220	25
20	120	19	18	34	24	230	41	72	440	77
40	240	39	38	70	48	461	101	144	879	128
60	360	64	65	85	72	691	149	216	1319	175

80	480	82	83	104	96	921	201	288	1758	193
100	600	93	92	123	120	1151	243	360	2198	202
<b>8 kg</b>										
		<b>Cartesian (X,Y)</b>			<b>J1</b>			<b>J3</b>		
acc/dec		100/100	100/100	100/100	25/25			300/100		
dist. (mm)		50	50	50	150			92		
dist. (deg)		-	-	-	15			15		
Speed (%)	mm/s	X(N)	Y(N)	Z(N)	deg/s	mm/s	J1(N)	deg/s	mm/s	N
10	60	6	13	22	12	115	18	36	220	38
20	120	17	21	41	24	230	35	72	440	79
40	240	35	41	71	48	461	70	144	879	140
60	360	55	66	90	72	691	143	216	1319	150
80	480	72	83	110	96	921	212	288	1758	160
100	600	89*	91*	133*	120	1151	257	360	2198	160

## Appendix K: ISO TS 15066 Test Results, Quasi-Static Contact

Quasi-static contact testing with 1, 4, and 8 kg payloads. Forces in green mean that they are within specification.

### Examples:

- To keep the robot's Z forces within specification, keep the speed less than or equal to 40%
- For J3 in the 8 kg payload example below, to keep the robot's forces within specification maintain the speed at or below 144 degrees per second or 879 mm per second.

1 kg										
	Cartesian (XY,Z)				J1			J3		
	acc/dec	100/100	100/100	100/50			25/15			300/25
	dist. (mm)	35	35	20			15			92
	dist. (deg)	-	-	-			1.5			15
Speed (%)	mm/s	X(N)	Y(N)	Z(N)	deg/s	mm/s	J1(N)	deg/s	mm/s	N
10	60	29	76	211	12	115	70	36	220	69
20	120	36	75	221	24	230	80	72	440	130
40	240	74	103	255	48	461	132	144	879	179
60	360	108	121	285	72	691	130	216	1319	175
80	480	126	132	304	96	921	280	288	1758	175
100	600	140*	144*	319	120	1151	240	360	2198	175
4 kg *										
	Cartesian (XY,Z)				J1			J3		
	acc/dec	100/100	100/100	100/50			25/15			300/25
	dist. (mm)	35	35	20			15			92
	dist. (deg)						1.5			15

Speed (%)	mm/s	X(N)	Y(N)	Z(N)	deg/s	mm/s	J1(N)	deg/s	mm/s	N
10	60	28	77	206	12	115	73	36	220	103
20	120	46	81	222	24	230	91	72	440	172
40	240	99	120	260	48	461	131	144	879	217
60	360	133	150	290	72	691	154	216	1319	225
80	480	158	174	313	96	921	250	288	1758	224
100	600	182	176	328	120	1151	250	360	2198	224
<b>8 kg</b>										
	<b>Cartesian (X,Y)</b>				<b>J1</b>			<b>J3</b>		
	acc/dec	100/100	100/100	100/50			25/15			300/25
	dist. (mm)	35	35	20			15			92
	dist. (deg)						1.5			15
Speed (%)	mm/s	X(N)	Y(N)	Z(N)	deg/s	mm/s	J1(N)	deg/s	mm/s	N
10	60	28	77	209	12	115	66	36	220	113
20	120	60	84	223	24	230	95	72	440	200
40	240	122	140	266	48	461	225	144	879	280
60	360	175	168	301	72	691	280	216	1319	305
80	480	207	193	328	96	921	-	288	1758	305
100	600	214	203	341	120	1151	-	360	2198	310



## Appendix L: Comparison of Plastic and Foam Covers

### Impact Force

Brooks updated the PreciseFlex Direct Drive covers from foam to plastic and conducted comparison impact tests. Here are the test results, which will help users design applications to avoid collisions against a rigid surface that might injure a person.

**NOTE:** Collisions in free space are not a problem as an operator's hand or forearm can bounce off the covers and the forces are within limits up to 100% speeds.

If the robot satisfies the conditions indicated in the green cells of the "J1 Comparison Table, Measured Force, 1 kg Payload" and "J3 Comparison Table, Measured Force, 1 kg Payload" tables below, it is setup is within the force limits defined by [ISO/TS 15066](#).

- Test results vary for different points of contact. The point of contact in these tests is close to the edge of the plastic cover. Higher forces were recorded when the impact was closer to the edge of the cover where the plastic is more rigid and there is less deflection
- 1 kg payload (contact force in N).
- Impact distance 1.5 deg. (approximately 15 mm @ 550 mm) (J3 @90 deg)

**J1 Comparison Table, Measured Force, 1 kg Payload**

			Deceleration					
			15		20		25	
			Foam covers	Plastic covers (edge)	Foam covers	Plastic covers (edge)	Foam covers	Plastic covers (edge)
Speed (%)	Speed (deg/s)	Speed (mm/s)						
10%	12	115	70	82	70	92	77	96
20%	24	230	80	105	83	112	92	129
30%	36	345	95	121	113	136	135	151
40%	48	461	132	144	140	158	140	168
50%	60	576	150	149	260	177	240	183
60%	72	691	130	160	159	186	200	192
70%	84	806	150	165	300	218	310	225

80%	96	921	280	185	300	241	300	240
90%	108	1036	280	205	300	250	305	255
100%	120	1151	240	231*	305	263	305	264

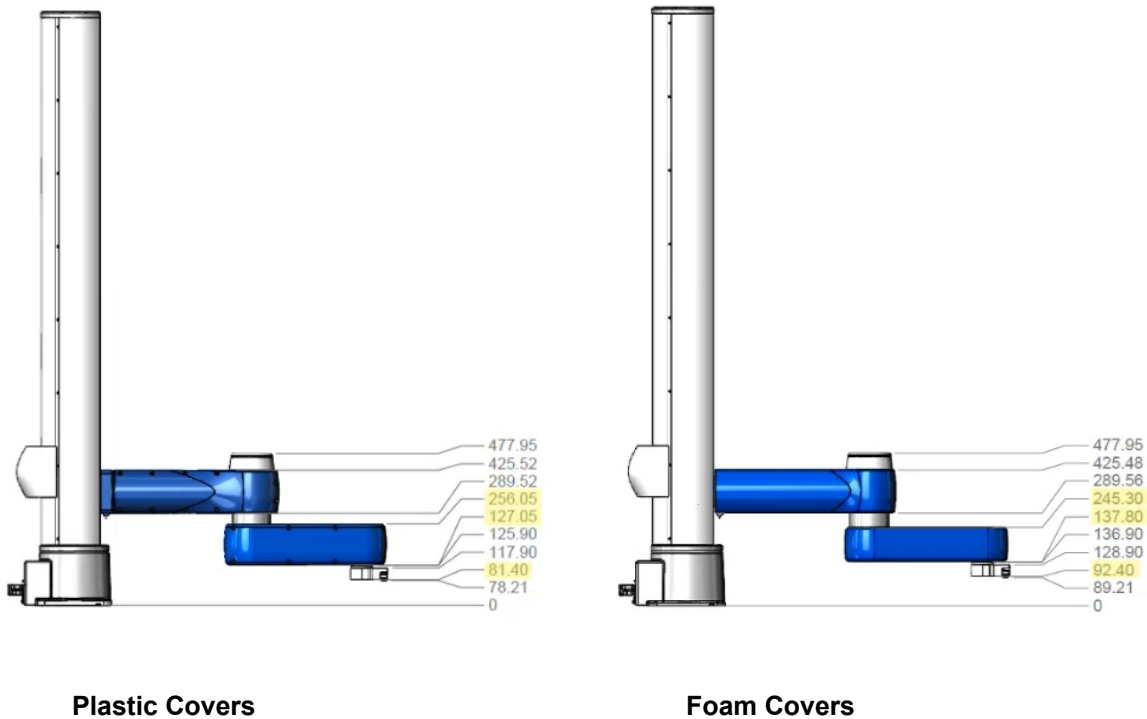
**J3 Comparison Table, Measured Force, 1 kg Payload**

			Foam covers	Plastic covers (edge)
<b>Payload</b>			1kg	1kg
<b>Acc/dec (%)</b>			300/25	300/25
<b>Distance (deg)</b>			15	15
<b>Distance (mm)</b>			92	92
<b>Par. 2707</b>			0	0
<b>Speed (%)</b>	<b>Speed (deg/s)</b>	<b>Speed (mm/s)</b>	<b>Impact force (N)</b>	<b>Impact force (N)</b>
10	36	220	69	76
20	72	440	130	115
30	108	659	167	135
40	144	879	179	149
50	180	1099	175	165
60	216	1319	175	181
70	252	1539	175	193
80	288	1758	175	202
90	324	1978	175	213
100	360	2198	175	234*

## Arm Dimensions

Most robot dimensions do not change. The outer link plastic covers are taller than the foam covers so the mounting screw bosses could be integrated into the halves of the covers, and the plastic covers can be retrofitted to robots with foam covers with the use of custom adapters. This helps the user update to plastic covers, which will not require a return to factory service. Email [support@preciseflex@brooksautomation.com](mailto:support@preciseflex@brooksautomation.com) for more details.

On robots with plastic covers, the ISO flange has shifted 11 mm lower to extend below the bottom of the thicker plastic cover. The robots also have an internal pulley in a lower position to facilitate the ISO flange position. See the graphics and table below.



**Arm Dimensions**

Dimensioned Part	Plastic Covers Version	Foam Covers Version
Bottom of Base Plate	0	0
Bottom of Finger Mounts	78.21	89.21
Bottom of Gripper Frame	81.40	92.40

Dimensioned Part	Plastic Covers Version	Foam Covers Version
Top of Gripper Frame/Bottom of 23 N Gripper Adapter Flange	117.90	128.90
Bottom of ISO Flange with Pulley	125.90	136.90
Bottom of Outer Link Cover	127.05	137.80
Top of Outer Link Cover	256.05	245.30
Bottom of Inner Link Cover	289.52	289.56
Top of Inner Link Cover	425.52	425.48
Top of LED Tower	477.95	477.95